



Free Floating Lever Drain Traps

For Loads to 50,000 lb/hr (22,679 kg/hr)...Pressures to 1,000 psig (69 bar)

Table LD-14. Maximum Operating Pressures for Handling Different Specific Gravity Liquids With Orifices Available in Guided Free Floating Lever Drain Traps. (See pages LD-29 and LD-30.)

Model No.	Sp. Grav.	1.00		.95		.90		.85		.80		.75		.70		.65		.60		.55		.50	
		Maximum Operating Pressure psig (bar)																					
		in	psig	bar	psig	bar	psig	bar	psig	bar	psig	bar	psig	bar	psig	bar	psig	bar	psig	bar	psig	bar	psig
1-LD	1/8	121	8.3	109	7.6	98	6.8	87	6.0	75	5.2	64	4.4	52	3.6	41	2.8	29	2.0	18	1.2	6	0.4
	7/64	143	9.9	130	9.0	116	8.0	103	7.1	89	6.1	75	5.2	62	4.3	48	3.3	35	2.4	21	1.4	7	0.5
	#38	182	12.5	164	11	147	10.2	130	9.0	113	7.8	95	6.6	78	5.4	61	4.2	44	3.0	26	1.8	9	0.6
	5/64	300	20.7	289	19.9	259	17.8	228	15.7	198	13.7	168	11.6	137	9.5	107	7.4	77	5.3	47	3.2	16	1.1
11-LD	1/8	176	12.1	161	11.1	146	10.1	130	9.0	115	7.9	100	6.9	85	5.8	69	4.8	54	3.7	39	2.7	24	1.6
	7/64	209	14	191	13	173	12	155	10.7	137	9.4	119	8.2	100	6.9	82	5.7	64	4.4	46	3.2	28	1.9
	#38	264	18	242	17	219	15	196	14	173	12	150	10.4	127	8.8	104	7.2	81	5.6	59	4.0	36	2.5
	5/64	400	28	400	28	384	27	344	24	304	21	264	18	224	15	183	13	143	9.9	103	7.1	63	4.3
2-LD to 250 psi (17 bar)	5/16	22	1.5	20	1.4	18	1.3	17	1.1	15	1.0	13	0.9	11	0.8	10	0.7	8	0.5	6	0.4	4	0.3
	1/4	36	2.5	33	2.3	30	2.1	27	1.9	24	1.7	22	1.5	19	1.3	16	1.1	13	0.9	10	0.7	7	0.5
	3/16	79	5.5	73	5.0	67	4.6	60	4.2	54	3.7	47	3.3	41	2.8	35	2.4	28	2.0	22	1.5	16	1.1
	5/32	137	9.4	126	8.7	115	7.9	104	7.2	93	6.4	82	5.6	71	4.9	60	4.1	49	3.4	38	2.6	27	1.8
22-LD to 533 psi (475 bar)	1/8	234	16.1	215	14.8	196	13.5	178	12.2	159	10.9	140	9.6	121	8.4	102	7.1	83	5.8	65	4.5	46	3.2
	7/64	299	20.6	275	19	251	17.3	227	15.7	203	14	179	12	155	10.7	131	9.0	107	7.4	83	5.7	59	4.0
	#38	372	25.7	342	23.6	313	21.6	283	19.5	253	17.4	223	15	193	13	163	11.2	133	9.2	103	7.1	73	5.0
	5/64	533	37	475	33	461	32	417	29	372	26	328	23	284	20	240	17	196	14	152	10.5	108	7.4
32-LD	5/16	29	2.0	26	1.8	23	1.6	21	1.4	18	1.2	15	1.0	12	0.9	10	0.7	7	0.5	4	0.3	2	0.1
	1/4	47	3.3	43	3.0	38	2.6	34	2.3	29	2.0	25	1.7	20	1.4	16	1.1	12	0.8	7	0.5	3	0.2
	3/16	104	7.2	94	6.5	85	5.8	75	5.2	65	4.5	55	3.8	45	3.1	35	2.4	25	1.8	16	1.1	6	0.4
	5/32	180	12	163	11	146	10	129	8.9	112	7.7	95	6.5	78	5.4	61	4.2	44	3.0	27	1.9	10	0.7
3-LD to 250 psi (17 bar) (Cast Iron)	1/8	307	21	278	19	249	17	220	15	191	13	162	11	133	9	104	7.2	75	5.2	46	3.2	17	1.2
	7/64	393	27	356	25	319	22	282	19	245	17	207	14	170	12	133	9	96	6.6	59	4.1	22	1.5
	#38	489	34	443	31	397	27	351	24	304	21	258	18	212	15	166	11	120	8	73	5.1	27	1.9
	5/64	600	41	600	41	585	40	517	36	449	31	381	26	313	22	244	17	176	12	108	7	40	2.8
13-LD to 570 psi (39 bar) (Stainless)	1/2	16	1.1	14	1.0	13	0.9	12	0.8	10	0.7	9	0.6	7	0.5	6	0.4	5	0.3	3	0.2	2	0.1
	3/8	33	2.3	31	2.1	28	1.9	25	1.7	22	1.5	19	1.3	16	1.1	13	0.9	10	0.7	7	0.5	4	0.3
	5/16	54	3.7	49	3.4	44	3.0	39	2.7	35	2.4	30	2.1	25	1.7	20	1.4	16	1.1	11	0.8	6	0.4
	9/32	71	4.9	65	4.5	59	4.0	52	3.6	46	3.2	40	2.7	34	2.3	27	1.9	21	1.4	15	1.0	8	0.6
33-LD to 900 psi (62 bar) (Steel)	1/4	107	7.4	97	6.7	88	6.1	79	5.4	69	4.8	60	4.1	50	3.5	41	2.8	32	2.2	22	1.5	13	0.9
	7/32	153	10.5	139	9.6	126	8.7	112	7.7	99	6.8	85	5.9	72	5.0	59	4.0	45	3.1	32	2.2	18	1.2
	3/16	230	16	209	14	189	13	169	12	149	10.3	129	8.9	108	7.5	88	6.1	68	4.7	48	3.3	27	1.9
	5/32	359	25	327	23	296	20	264	18	233	16	201	14	169	12	138	9.5	106	7.3	74	5.1	43	2.9
6-LD Cast Iron	1/8	726	50	662	46	598	41	534	37	470	32	406	28	342	24	278	19	214	15	150	10.3	86	5.9
	7/64	900	62	847	58	765	53	683	47	601	41	519	36	437	30	356	25	274	19	192	13	110	7.6
	1-1/16	21	1.4	19	1.3	18	1.2	16	1.1	15	1.0	13	0.9	12	0.8	10	0.7	9	0.6	7	0.5	6	0.4
	7/8	32	2.2	30	2.1	28	1.9	26	1.8	23	1.6	21	1.4	19	1.3	16	1.1	14	1.0	12	0.8	9	0.6
36-LD Forged Steel	3/4	47	3.2	44	3.0	40	2.8	37	2.5	34	2.3	30	2.1	27	1.9	24	1.6	20	1.4	17	1.2	14	0.9
	5/8	72	4.9	67	4.6	61	4.2	56	3.9	51	3.5	46	3.2	41	2.8	36	2.5	31	2.1	26	1.8	21	1.4
	9/16	95	6.5	88	6.1	81	5.6	75	5.2	68	4.7	61	4.2	55	3.8	48	3.3	41	2.8	34	2.4	28	1.9
	1/2	138	9.5	128	8.8	118	8.1	108	7.5	99	6.8	89	6.1	79	5.4	69	4.8	59	4.1	50	3.4	40	2.8
NOTE: If specific gravity falls between those shown in the chart, use the next lower gravity. For example, if specific gravity is 0.73, use 0.70 gravity data.	7/16	196	13	182	13	168	12	154	11	140	10	126	8.7	112	7.7	98	6.8	85	5.8	71	4.9	57	3.9
	3/8	250	17	250	17	250	17	243	17	221	15	199	14	177	12	155	11	133	9.0	111	7.7	90	6.2
	11/32	250	17	250	17	250	17	250	17	250	17	250	17	250	17	236	16	207	14	178	12	148	10
	5/16	250	17	250	17	250	17	250	17	250	17	250	17	250	17	250	17	250	17	228	16	191	13
High Temperature Service	9/32	250	17	250	17	250	17	250	17	250	17	250	17	250	17	250	17	250	17	250	17	250	17
	1/4	250	17	250	17	250	17	250	17	250	17	250	17	250	17	250	17	250	17	250	17	250	17
	7/32	250	17	250	17	250	17	250	17	250	17	250	17	250	17	250	17	250	17	250	17	250	17
	3/16	250	17	250	17	250	17	250	17	250	17	250	17	250	17	250	17	250	17	250	17	250	17
Specific Gravity		1.00		.95		.90		.85		.80		.75		.70		.65		.60		.55		.50	

High Temperature Service

Maximum allowable working pressures of floats decrease at temperatures above 100°F (37.8°C). Allow for approximately:

- 10% decrease at 200°F (93.3°C)
- 15% decrease at 300°F (148.9°C)
- 20% decrease at 400°F (204.4°C)

The float is not always the limiting factor, however. Consult with Armstrong Application Engineering if you have a high-temperature application that also requires maximum operating pressures.

Liquid Drainers

Free Floating Guided Lever Drain Traps

For Loads to 49,000 lb/hr (22,226 kg/hr)...Pressures to 300 psig (21 bar)



Armstrong's cast iron, free-floating guided lever drain traps use the same bodies, caps, lever mechanisms, valves and seats of Armstrong inverted bucket steam traps that have been proven in years of service. Elliptical floats and high leverage make it possible to open large orifices to provide adequate capacity for drain trap size and weight.

The hemispherical valve, seat and leverage of the 1-LD, 2-LD, 3-LD and 6-LD cast iron traps are identical in design, materials and workmanship to those for saturated steam service up to 300 psig (21 bar) with the exception of the addition of a guidepost to assure a positive, leaktight valve closing under all conditions.

List of Materials

Model No.	Valve & Seat	Leverage System	Float	Body & Cap	Gasket
1-LD 2-LD 3-LD 6-LD	Stainless Steel			Cast Iron ASTM A48 Class 30	Compressed Asbestos-free

For information on special materials, consult the Armstrong Application Engineering Department.

For a fully detailed certified drawing, refer to:

1-LD CD #1070
2-LD, 3-LD, 6-LD CD #1034

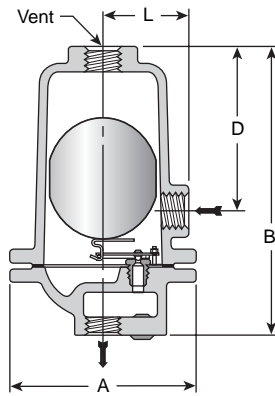

Figure LD-33.

No. 2-LD, 3-LD and 6-LD cast iron guided lever drain traps. No. 1-LD has standard top inlet and optional side connection.



Physical Data

Model No.	Cast Iron							
	1-LD		2-LD		3-LD		6-LD	
Pipe Connections	in	mm	in	mm	in	mm	in	mm
	1/2*	15*	1/2, 3/4	15, 20	1/2, 3/4, 1	15, 20, 25	1-1/2, 2	40, 50
"A"	3-3/4	95	5-1/4	133	6-3/8	162	10-3/16	259
"B"	5-1/2	140	8	203	10-5/8	270	17	432
"D"	2-7/8	73	4-3/8	111	6-3/32	155	8-3/8	213
"K" (¢ Outlet to ¢ Inlet)	13/16	21	—	—	—	—	—	—
"L"	1-7/8	48	2-7/16	62	2-7/8	73	4-5/8	117
Approx. Wt. lb (kg)	4 (2)		13 (6)		22 (10)		80 (36)	
Max. Allow. Pressure (Vessel Design)	300 psig @ 200°F† (21 bar @ 93°C)				250 psig @ 450°F (17 bar @ 232°C)			

NOTE: Vessel design pressure may exceed float collapse pressure in some cases.

Pipe size of vent connection is same as that of inlet and outlet connections.

*1/4" (6 mm) outlet.

† For pressures not exceeding 250 psig (17 bar), a maximum temperature of 450°F (232°C) is allowed.

All dimensions and weights are approximate. Use certified print for exact dimensions. Design and materials are subject to change without notice.



Free Floating Guided Lever Drain Traps

For Loads to 9,500 lb/hr (4,309 kg/hr)...Pressures to 570 psig (39 bar)

Armstrong's stainless steel, free-floating guided lever drain traps use the same bodies, caps, lever mechanisms, valves and seats of Armstrong inverted bucket steam traps that have been proven in years of service. Elliptical floats and high leverage make it possible to open large orifices to provide adequate capacity for drain trap size and weight.

The hemispherical valve, seat and leverage of the 11-LD, 22-LD and 13-LD stainless steel traps are identical in design, materials and workmanship to those for saturated steam service up to 570 psig (39 bar) with the exception of the addition of a guidepost to assure a positive, leaktight valve closing under all conditions.

List of Materials

Table LD-17.					
Model No.	Valve & Seat	Leverage System	Float	Body & Cap	Gasket
11-LD 22-LD 13-LD	Stainless Steel			Sealed Stainless Steel, 304L	—

For information on special materials, consult the Armstrong Application Engineering Department.

For a fully detailed certified drawing, refer to list below:

- 11-LD CD #1066
- 13-LD and 22-LD CD #1086

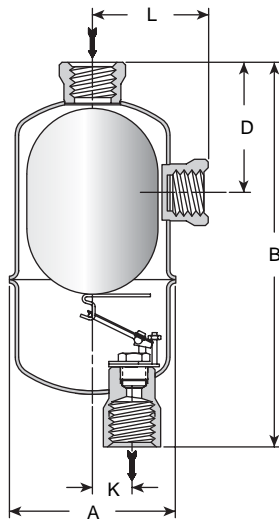

Figure LD-34.

No. 11-LD, 22-LD and 13-LD stainless steel guided lever liquid drain trap with sealed, tamperproof construction.



Physical Data

Model No.	Table LD-18. Armstrong Guided Lever Liquid Drain Traps					
	Stainless Steel					
	11-LD**		22-LD		13-LD	
Pipe Connections	in	mm	in	mm	in	mm
	3/4*	20*	3/4	20	1	25
"A"	2-3/4	70	3-15/16	100	4-1/2	114
"B"	7-1/4	184	8-13/16	224	11-3/8	289
"D"	—	—	3	76	6-1/8	156
"K"	9/16	14	7/8	22	1-3/16	30
"L"	—	—	2-5/8	67	3-9/32	83
Approx. Wt. lbs (kg)	1-3/4 (0.79)		3-1/4 (1.5)		7-1/2 (3.4)	
Max. Allowable Pressure (Vessel Design)	500 psig @ 100°F (35 bar @ 38°C) 440 psig @ 500°F (30 bar @ 260°C)		600 psig @ 100°F (41 bar @ 38°C) 475 psig @ 500°F (33 bar @ 260°C)		570 psig @ 100°F (39 bar @ 38°C) 490 psig @ 500°F (34 bar @ 260°C)	

Note: Vessel design pressure may exceed float collapse pressure in some cases. Pipe size of vent connection is same as that of inlet and outlet connections. *1/2" (15 mm) outlet. **No side connection.

All dimensions and weights are approximate. Use certified print for exact dimensions. Design and materials are subject to change without notice.

Liquid Drainers

180 Series Free Floating Lever Drain Traps

All Stainless Steel for Horizontal Installation

For pressures to 400 psig (28 bar) . . . Capacities to 2,000 lb/hr (907 kg/hr)



Armstrong's stainless steel, free-floating guided lever drain traps use the same bodies, caps, lever mechanisms, valves and seats as Armstrong inverted bucket steam traps that have been proven in years of service. Elliptical floats and high leverage make it possible to open large orifices to provide adequate capacity for drain trap size and weight.

The hemispherical valve, seat and leverage of the 180-LD and 181-LD stainless steel traps are identical in design, materials and workmanship to those for saturated steam traps service up to 570 psig (39 bar), except that the 180 Series traps have a guidepost to ensure a positive, leak-tight valve closing under all conditions. The 180 Series is designed for situations where mounting a drainer close to the floor is critical. A back vent connection is required.

For a fully detailed certified drawing, refer to list below:

180-LD CD #1276

181-LD CD #1276



List of Materials

Model No.	Valve & Seat	Leverage System	Float	Body & Cap
180-LD 181-LD	Stainless Steel			Sealed Stainless Steel 304L

Physical Data

Pipe Connections	in	mm	in	mm
	1/2	15	3/4	20
"A" (Diameter)	2-11/16	68	2-11/16	68
"B" (Height)	6	135	6-9/16	167
"C" (Face to Face)	4-5/16	110	4-5/16	110
"D" (Bottom to \varnothing Inlet)	5-1/8	113	5-9/16	141
Weight, lb (kg)	1-3/4 (0.8)		2-3/8 (1.1)	

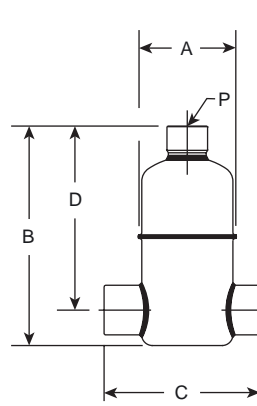

Figure LD-35.
Model 180-LD

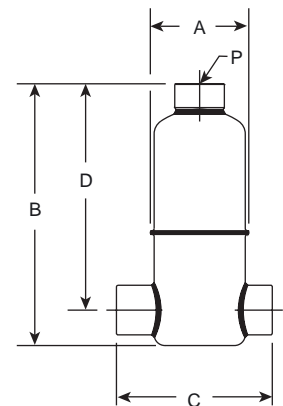
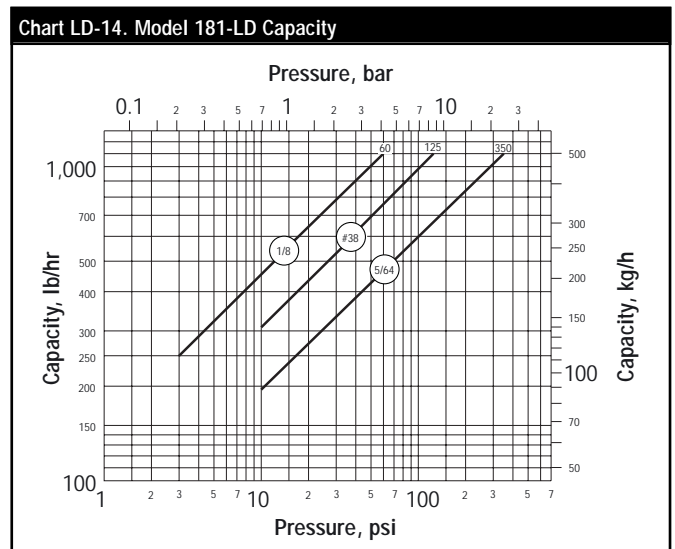
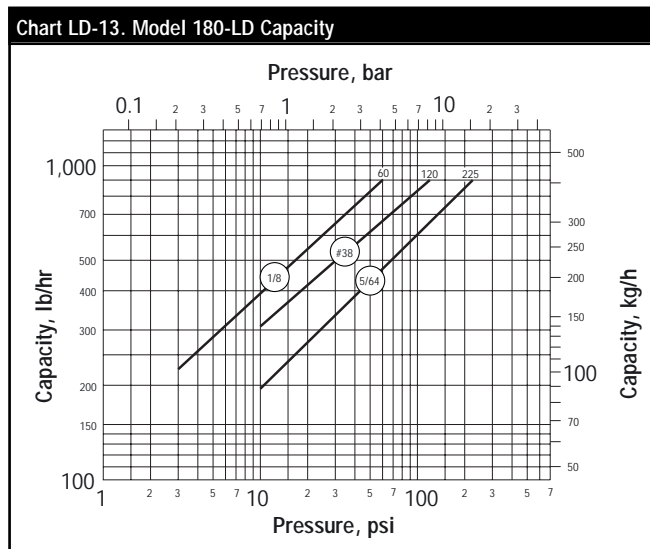

Figure LD-36.
Model 181-LD



All dimensions and weights are approximate. Use certified print for exact dimensions. Design and materials are subject to change without notice.

Free Floating Guided Lever Drain Traps

For Loads to 42,000 lb/hr (19,050 kg/hr)...Pressures to 1,000 psig (69 bar)

Armstrong's forged steel, free floating guided lever drain traps use the same bodies, caps, lever mechanisms, valves and seats of Armstrong inverted bucket steam traps that have been proven in years of service. Elliptical floats and high leverage make it possible to open large orifices to provide adequate capacity for drain trap size and weight.

The hemispherical valve, seat and leverage of the 32-LD, 33-LD and 36-LD forged steel traps are identical in design, materials and workmanship to those for saturated steam service up to 1,000 psig (69 bar) with the exception of the addition of a guidepost to assure a positive, leaktight valve closing under all conditions.

List of Materials

Model No.	Valve & Seat	Leverage System	Float	Body & Cap	Gasket
32-LD 33-LD 36-LD	Stainless Steel			Forged Steel ASTM A105	Compressed Asbestos-free

For information on special materials, consult the Armstrong Application Engineering Department.

For a fully detailed certified drawing, refer to CD #1035.

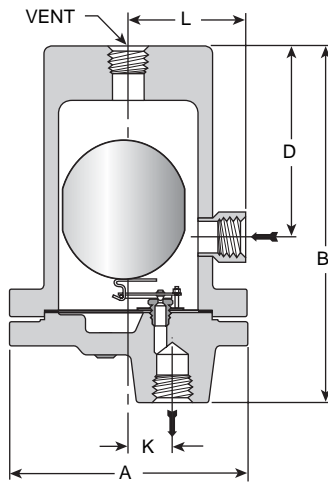

Figure LD-37.

No. 32-LD, 33-LD and 36-LD forged steel guided lever drain trap. Socketweld or flanged connections are also available.



Physical Data

Model No.	Forged Steel					
	32-LD†		33-LD†		36-LD†	
Pipe Connections	in	mm	in	mm	in	mm
	1/2, 3/4, 1	15, 20, 25	1/2, 3/4, 1	15, 20, 25	1-1/2, 2	40, 50
"A"	6-3/4	171	8	203	11-7/8	302
"B"	10-3/16	259	11-9/16	294	17-1/8	435
"D"	5-9/16	141	6-1/16	154	9	229
"K"	1-1/4	32	1-7/16	37	2-1/8	54
"L"	3-3/8	86	3-9/16	90	6-1/16	154
Approx. Wt. lbs (kg)	31 (14)		49 (22)		163 (74)	
Max. Allowable Pressure (Vessel Design)	600 psig @ 100°F (41 bar @ 38°C) 500 psig @ 750°F (35 bar @ 400°C)		1,000 psig @ 100°F (69 bar @ 38°C) 600 psig @ 750°F (41 bar @ 400°C)			

Note: Vessel design pressure may exceed float collapse pressure in some cases.

Pipe size of vent connection is same as that of inlet and outlet connections.

†Available in Type 316 stainless steel. Consult factory.