

# Chicago Faucet Sensor Operated Restroom Faucets

Chicago Faucet  
**116.606.AB.1**  
E-Tronic Series



**Lithium Battery Powered**  
for estimated 5-years of worry-free operation.

**Solid Construction and Fine Pricing!**

**Used with pre-tempered water applications**

Convert it to a point-of-use mixed water faucet with the manual hot and cold water mixing valve shown below.

Chicago Faucet  
**116.706.AB.1**  
E-Tronic Series



**AC, 12 Volt Powered**  
for worry-free, continuous operation. Transformers sold separately - See below.

*For multi-use transformer, order the **wire harness** separately.*

Chicago Faucet E-Tronic 40 series of institutional grade, traditional sink faucets deploying dual beam infrared sensors for precise control of automatic water flow. Available in both battery powered style and 12 volt AC power (with use of transformer) style. The robust design is meant to withstand the every day use encountered in schools, stadiums and other commercial and public restrooms. The faucet's ranges and modes of operation can be field adjusted to accommodate the desired point at which the faucet goes on and off. Chrome plated finish with "lead-free" brass construction: less than 0.25% per NSF/ANSI 372 low lead content.

Both battery and AC electrical powered styles are used in single-hole applications. The traditional electronic (battery or AC powered) integral spout delivers from 0.2 to 0.5 gpm via a vandal proof, non-aerating spray. Generally used for pre-tempered water, these faucets can be turned into a point-of-use mixing valve faucet by installing the below deck manual mixing valve shown below.

When using **AC powered faucets** you need to order either a single faucet application transformer or a multi-use faucet transformer:

- The single use transformer is a plug-in unit with the wire harness that connects to the faucet. Not included with faucet.
- The multi-use transformer is a plug-in unit with connections for up to 8 wire harnesses that connect to the desired faucets: The multi-use transformer and desired number of wire harnesses must be ordered separately.

The **battery-powered faucets** are powered by the included 6 volt lithium CRP2 battery - Power for up to 5-years of normal use.

Model	Battery-Powered Faucet	Order No.
116.606.AB.1	6V lithium battery powered faucet with dual beam, infrared sensing. Field adjustable modes and ranges.	<b>CE1146H</b>

Model	AC, 12-Volt Powered Faucet	Order No.
116.706.AB.1	AC, 12-volt powered faucet. Order the desired transformer below. Also order wiring harnesses if multi-faucet use.	<b>CE1146K</b>

## Thermostatic Mixing Valve



Model  
**131-ABNF**

### Chicago Faucet

- Installs between stop valves and the faucet; 3/8" compression connections.
- Single use or multiple faucet installations. Integral check valve prevents cross-flow.
- Lead-Free brass body: less than 0.25% lead content.
- Thermostat controls both hot and cold water. Temperature control range: 80° to 120° F.
- Minimum flow rate: 0.5GPM
- Maximum flow rate: 6.4 GPM
- Overall width: 4 7/8"

Description	Order No.
Chicago Faucet brass thermostatic mixing valve. 131-ABNF	<b>CF1082H</b>

## Transformers Convert 120V to 12V



Single Faucet Application

Multi-Faucet Applications

Model	Description	Order No.
240.630.00.1	Single Faucet Use, Plug-in with harness	<b>CE1146N</b>
242.559.00.1	Multi-Faucet (up to 8) Use, Plug-In	<b>CE1146P</b>
242.340.00.1	Wire Harness for Multi-Use transformer	<b>CE1146R</b>

# Chicago Faucet Sensor Operated Restroom Faucets

## EQ Sensor Operated Faucets



4" Center Model shown

### EQ Control Box

Color Coded wire connections make it easy to match up. Key adjustment components are molded in bright yellow for easy identification.

### Plug-and-Play Installation:

The faucet is up and running in minutes, not hours.

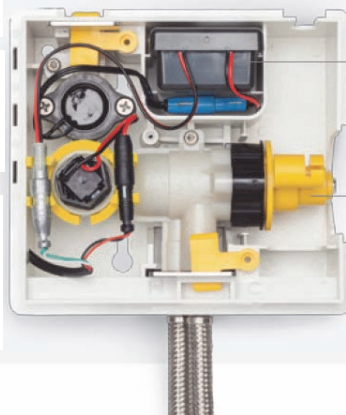

**Power Options** include battery, plug-in, hard wire or the SSPS self-sustaining power system: internal turbine powers battery for 10-years.

**Mixing Options** include mechanical or thermostatic mixer. Both can be adjusted with a simple turn of this lockable handle.

\*Optional **SSPS** Turbine Power Supply



The self-sustaining power system uses a hydraulic turbine to supply additional power to extend battery life up to 10 years!

### All the options in one neat little package:

If you've installed an electronic faucet before, then you know things can get a little messy under the sink. There's a box for the solenoid, sometimes another box for power, and if you want a thermostatic mixing valve, that's a separate product to fit under the sink. With EQ the solenoid, wire connections, and power module fit into this control box. If you ever decide to upgrade your control box in the future, the new box will fit in exactly the same space.

Put your hands under the faucet, water starts. Take them away, water stops. EQ has built-in intelligence that scans the room and recognizes when a user is approaching. When hands are placed under the spout, water flow begins immediately and continues for a maximum of 20 seconds. When the room gets crowded and usage increases, EQ automatically adjusts the maximum run-time to 10 seconds to help move more people and save more water.

### SINGLE HOLE EQ Faucets, Curved Chrome Plated Brass Spout

#### Single-Hole EQ Faucets



Curved Spout

#### Single or Dual Water Supplies



Dual Supply shown

Water Supply	Mixing	Power Supply	Flow Rate GPM	Construction	WGT lbs.	Chicago Model (Suffix -ABCP)	Order No.
Single, Pre-Mixed	For pre-mixed, tempered water: No mixing control in EQ Box	Battery	0.5	Brass Spout, Polished Chrome Plated <b>Single Hole</b>	4.5	EQ-A11A-11	CE1445
		Plug-In	0.5		5.0	EQ-A11A-31	CE1446
		Hard Wire	0.5		5.0	EQ-A11A-51	CE1447
		*SSPS	1.0		4.6	EQ-A11B-21	CE1448
Dual, Hot/Cold	Thermostatic Mixing Valve in EQ Control Box	Battery	0.5		4.8	EQ-A11A-13	CE1449
		Plug-In	0.5		4.8	EQ-A11A-13	CE1449
		Hard Wire	0.5		5.3	EQ-A11A-33	CE1450
		*SSPS	1.0		5.3	EQ-A11A-53	CE1451
	Mechanical Mixing Valve in EQ Control Box	Battery	0.5		4.9	EQ-A11B-23	CE1452
		Plug-In	0.5		4.7	EQ-A11A-12	CE1453
		Hard Wire	0.5		5.2	EQ-A11A-32	CE1454
		*SSPS	1.0		5.2	EQ-A11A-52	CE1455
				4.8	EQ-A11B-22	CE1456	

**"BEST BUY" EQ Faucets:** Chrome plated, robust "zinc" spout in place of a chrome plated brass spout

Single	For pre-mixed	Battery	0.5	Zinc Spout, Chrome Plated	4.8	EQ-D11A-11	CE1439
Dual, Hot/Cold	Mechanical Mixing		0.5	<b>Single Hole</b>	4.8	EQ-D11A-12	CE1440
	Thermostatic Mix		0.5		5.0	EQ-D11A-13	CE1441
Single	For pre-mixed	Battery	0.5	Zinc Spout, Chrome Plated	5.2	EQ-D12A-11	CE1442
Dual, Hot/Cold	Mechanical Mixing		0.5	<b>4" Centers</b>	5.3	EQ-D12A-12	CE1443
			0.5		5.5	EQ-D12A-13	CE1444

### 4" CENTERS EQ Faucets, Curved Chrome Plated Brass Spout

Single	For pre-mixed, tempered water: No mixing control in EQ Box	Battery	0.5	Brass Spout, Polished Chrome Plated <b>4" Centers</b>	5.0	EQ-A12A-11	CE1457
		Plug-In	0.5		5.5	EQ-A12A-31	CE1458
		Hard Wire	0.5		5.5	EQ-A12A-51	CE1459
		*SSPS	1.0		5.1	EQ-A12B-21	CE1460
Dual, Hot/Cold	Thermostatic Mixing Valve in EQ Control Box	Battery	0.5		5.3	EQ-A12A-13	CE1461
		Plug-In	0.5		5.8	EQ-A12A-33	CE1462
		Hard Wire	0.5		5.8	EQ-A12A-53	CE1463
		*SSPS	1.0		5.4	EQ-A12B-23	CE1464
	Mechanical Mixing Valve in EQ Control Box	Battery	0.5		5.3	EQ-A12A-12	CE1465
		Plug-In	0.5		5.7	EQ-A12A-32	CE1466
		Hard Wire	0.5		5.7	EQ-A12A-52	CE1467
		*SSPS	1.0		5.3	EQ-A12B-22	CE1468

#### 4" Centers



# Popular Chicago "Metered" Faucets for Rest Rooms

## Metering Sink Faucet for Pre-Tempered Water

- Chicago Faucet model 3500 is affordable and popular.
- A single water supply line delivers pre-tempered water.
- 0.5 gpm flow cycle time adjustable from 5- to 20-seconds.
- One stainless steel supply hose included.
- Lead content approved at 0.25% or under.
- Chrome plated finish over brass construction.
- Choose from 4", 8" or single-hole models.

### 3500-8

- For pre-tempered water
- One water supply line
- 8" center x center

### 3501-8

- For mixing hot & cold
- Two water supply lines
- Internal temp. control
- 8" center x center



## Metering Sink Faucet Mixes Hot & Cold Water

- Chicago Faucet model 3501 mixes water at faucet.
- Dual water supply lines for both Hot & Cold water.
- Concealed, internal temperature control & hot water limit stop.
- 0.5 gpm flow cycle time adjustable from 5- to 20-seconds.
- Two stainless steel supply hoses included.
- Chrome plated finish, brass construction. Lead under .025%
- Choose from 4", 8" or single-hole models.

### 3500-4

- For pre-tempered water
- One water supply line
- 4" center x center

### 3501-4

- For mixing hot & cold
- Two water supply lines
- Internal temp. control
- 4" center x center



### 3500

- For pre-tempered water
- One water supply line
- One-hole supply

### 3501

- For mixing hot & cold
- Two water supply lines
- Internal temp. control
- One-hole supply



Model No.	Description	Order No.
<b>Model 3500 for Pre-Tempered Water</b>		
3500-4	4" center x center, one supply line	<a href="#">CE1405</a>
3500-8	8" center x center, one supply line	<a href="#">CE1410</a>
3500	One-hole application, one supply line	<a href="#">CE1415</a>
<b>Model 3501 for Mixing Hot &amp; Cold Water</b>		
3501-4	4" center x center, two supply lines	<a href="#">CE1420</a>
3501-8	8" center x center, two supply lines	<a href="#">CE1425</a>
3501	One-hole application, two supply lines	<a href="#">CE1430</a>

Chicago Faucets are made via ECAST construction: All body construction content is brass with a chrome plated finish. The lead content within the body is equal to or less than 0.25% lead content by weighted average. This low lead content conforms with all institutional regulations mandating low lead content valves when applied in areas where potable consumption of water is supplied and distributed.

# Chicago Manual Faucets for Lavatories

## Manually Operated Metered and Standard Faucets for Rest Rooms

The popular choice for rest rooms in commercial buildings and public institutions. Choose from manually operated lever handle, or push handle slow-close ADA approved faucets with a metered flow of water, usually from 5– to 20-seconds.

- Includes standard 1/2" NPSM coupling nut for 3/8" or 1/2" flexible riser. ■ Cold and Hot water supplies spaced 4" center-by-center. ■ All faucets are brass with a polished chrome plated finish.

### The Popular Faucets Found in Public Restrooms Everywhere!



- Vandal-resistant aerators and metered water flow using the MVP Metering cartridges — Adjust the water flow time from 5 to 20 seconds. Found in public institutions around the world!
- Deck mounted, ADA approved EZ-Push self-closing faucet. 4" integral spout, and 4" center x center supply connections.
- Choose 2 gpm or 0.5 gpm water flow models.

Model No.	Description	Order No.
802V-665	Metered lavatory faucet, 2 gpm flow	<a href="#">CE1221</a>
802V-E2805-665	Metered lavatory faucet, 0.5 gpm flow	<a href="#">CE1209A</a>



802V-CP

- Vandal-resistant aerators and 2½" handles.
- Deck mounted, two-handle manual closing faucet with 4" integral spout, and 4" center x center supply connections.
- Choose 2 gpm or 0.5 gpm water flow models.

Model No.	Description	Order No.
802V-CP	Lavatory faucet, 2 gpm flow	<a href="#">CE1210</a>
802V-E2805	Lavatory faucet, 0.5 gpm flow	<a href="#">CE1209</a>



802V-317CP

- Vandal-resistant aerators and 4" handi-cap blade handles.
- Deck mounted, two-handle manual closing faucet with 4" integral spout, and 4" center x center supply connections.
- Choose 2 gpm or 0.5 gpm flow models.

Model No.	Description	Order No.
802V-317CP	Lavatory faucet, 2 gpm flow	<a href="#">CE1211</a>
802V-317-E2805	Lavatory faucet, 0.5 gpm flow	<a href="#">CE1211A</a>



802V-1000

- Vandal-resistant aerators for public and commercial places.
- Deck mounted, wing handle manual closing faucet with 4" integral spout, and 4" center x center supply connections.
- Choose 2 gpm or 0.5 gpm water flow models.

Model No.	Description	Order No.
802V-1000	Lavatory faucet, 2 gpm flow	<a href="#">CE1265</a>
802VE2805-1000	Lavatory faucet, 0.5 gpm flow	<a href="#">CE1221H</a>



802V-335

- Vandal-resistant aerators and Tip-Tap push-tilt handles.
- Deck mounted, metered push closing faucet with 4" integral spout, and 4" center x center supply connections.
- Adjust water flow from 2 to 15 seconds.

Model No.	Description	Order No.
802V-335	Lavatory faucet, 2 gpm flow	<a href="#">CE1220</a>
802VE2805-335	Lavatory faucet, 0.5 gpm flow	<a href="#">CE1220A</a>

# Chicago Manual Faucets for Lavatories

## For Single- or Two-Hole Lavatory Applications

■ These self-closing, single basin faucets have an adjustable time cycle (adjusted by an allen wrench) from 3 to 15 seconds of water flow time. ■ Most faucets utilize a standard E-12 faucet aerator (3/16" - 27 female thread connections), providing a soft flow of water and resistance to mineral build-up. ■ All faucets have a standard 1/2" NPSM coupling nut for connection to either a 3/8" or 1/2" flexible supply riser. ■ See www.StateSupply.com/Chicago-Faucets for product documentation.



*The Popular One!*

333-665

### Easy-Push, self-closing single basin faucet

- Deck mounted, single-handle self-closing faucet with 3-3/8" integral spout. ADA approved.
- Chrome plated faucets with "MVP" self-closing valve, adjustable 2 to 20 seconds.
- No. 665 push-down handle indexed "Push."

Model No.	Description	Order No.
333-665PUSHCP	Indexed "Push"	<b>CE1088B</b>



333-SLOE12

### Standard-Push, self-closing single basin faucet

- Deck mounted, single-handle self-closing faucet with 3-3/8" integral spout.
- Chrome plated faucets with NAIAD self-closing valve, adjustable 2 to 15 seconds.
- No. 333 push-handle indexed for "Cold" or "Push"

Model No.	Description	Order No.
333-SLOE12PSHCP	Indexed "Push"	<b>CE1080</b>
333-SLOE12COLD	Indexed "Cold"	<b>CE1075</b>



333-336

### Lever handle, self-closing single basin faucet

- Deck mounted, lever handle self-closing faucet with 3-3/8" integral spout.
- Chrome plated faucets with NAIAD self-closing valve, adjustable from 2 to 15 seconds.
- No. 336 push-tilt handle indexed "Push"

Model No.	Description	Order No.
333-336PUSHCP	Indexed "Push"	<b>CE1089</b>



335-E12

### Tip-Tap, self-closing single basin faucet

- Deck mounted, single-handle metered faucet with 3-3/8" integral spout.
- Chrome plated faucets with push-tilt, self-closing valve, adjustable 2 to 15 seconds.
- No. 335 push-tilt handle indexed "Cold" or "Push."

Model No.	Description	Order No.
335-E12PUSHCP	Indexed "Push"	<b>CE1089A</b>



700

### Manual-Closing single basin faucet

- Deck mounted, single-handle manual closing faucet with 3-3/8" integral spout.
- Chrome plated faucets with "Quatern" standard manually operated, repairable cartridge.
- No. 633 cross handle indexed for "Cold" or "Hot"

Model No.	Description	Order No.
700-COLDCP	Indexed "Cold"	<b>CE1161</b>
700-HOTCP	Indexed "Hot"	<b>CE1160</b>



701

### Self-Closing single basin faucet

- Deck mounted, single-handle self-closing faucet with 3-3/8" integral spout.
- Chrome plated faucets with "Klo-Self" self-closing valve, adjustable from 2 to 15 seconds.
- No. 633 cross handle indexed for "Cold" or "Hot"

Model No.	Description	Order No.
701-COLDCP	Indexed "Cold"	<b>CE1166</b>
701-HOTCP	Indexed "Hot"	<b>CE1165</b>

# Chicago Manual Faucets for Lavatories

## Manually Operated Faucets for your Lavatories and Rest Rooms

You'll find these manually operated faucets installed in commercial buildings and public institutions. Choose from manually operated lever handle, or push handle, slow-close ADA approved faucets with vandal-resistant handles.

- Includes standard 1/2" NPSM coupling nut for 3/8" or 1/2" flexible riser.
- Cold and Hot water supplies spaced 4" center-by-center.
- All faucets are brass, polished chrome plated finish & vandal-resistant handles and aerators.

### Wing Handles



802V-1000

- Vandal-resistant aerators for public and commercial places.
- Deck mounted, wing handle manual closing faucet with 4" integral spout, and 4" center x center supply connections.
- Choose 2 gpm or 0.5 gpm water flow models.



802V-335

### Push-Activated Faucet, 2-15 second operation

- Vandal-resistant aerators and Tip-Tap push-tilt handles.
- Deck mounted, metered push closing faucet with 4" integral spout, and 4" center x center supply connections.
- Adjust water flow from 2 to 15 seconds.

Model No.	Description	Order No.
802V-1000	Lavatory faucet, 2 gpm flow	<a href="#">CE1265</a>
802VE2805-1000	Lavatory faucet, 0.5 gpm flow	<a href="#">CE1221H</a>

Model No.	Description	Order No.
802V-335	Lavatory faucet, 2 gpm flow	<a href="#">CE1220</a>
802VE2805-335	Lavatory faucet, 0.5 gpm flow	<a href="#">CE1220A</a>



797V-317

### Standard Faucet with Wrist Blade Handles

- Vandal-resistant aerators with 4" handicap blade handles and 1-1/4" diameter pop-up assembly; top diameter at sink outlet is 2-1/8".
- Manual closing faucet with 802 body, 4" integral spout, and 4" center x center supply connections.



797V

### Standard Faucet with Standard Blade Handles

- Vandal-resistant aerators with standard blade handles and 1-1/4" diameter pop-up assembly; top diameter at sink outlet is 2-1/8".
- Manual closing faucet with 802 body, 4" integral spout, and 4" center x center supply connections.

Model No.	Description	Order No.
797V-317	Lavatory faucet, 2.2 gpm flow	<a href="#">CE1206</a>

Model No.	Description	Order No.
797V	Lavatory faucet, 2.2 gpm flow	<a href="#">CE1205</a>



797V-665

### Push-Activated Faucet ADA, adjustable 5-20 sec. flow

- Vandal-resistant aerators with ADA push-down handles and 1-1/4" diameter pop-up assembly; top diameter of pop-up at sink outlet is 2-1/8".
- Self-closing metered faucet (adjustable 5- to 20 seconds) with 4" integral spout, and 4" center x center supply connections.



797V-336

### Push-Activated Faucet, 5-20 second adjustable flow

- Vandal-resistant aerators with push-down metered handles: water flow adjustable from 5- to 20-seconds. 1-1/4" diameter pop-up assembly; top diameter of pop-up at sink outlet is 2-1/8".
- Self-closing faucet with 4" integral spout, and 4" center x center supply connections.

Model No.	Description	Order No.
797V-665	Lavatory faucet, 2.2 gpm flow	<a href="#">CE1208</a>

Model No.	Description	Order No.
797V-336	Lavatory faucet, 2.2 gpm flow	<a href="#">CE1207A</a>

# Widespread Chicago Faucets and Service Sink Units

## Manually Operated Faucets, 8" and 12" widespread connections



404V-317

### 8" center x center and handicap blade handles

- Vandal-resistant aerators supplying 2 gpm of water.
- Deck mounted, handicap handle manual closing faucet with 5" spout, and 8" center x center supply connections.

Model No.	Description	Order No.
404V-317	8" widespread lavatory faucet	<a href="#">CE1126</a>
404V	Like above, but standard cross handles in place of handicap handles	<a href="#">CE1124</a>



404V-665

### 8" center x center and easy-push metered handles

- Vandal-resistant aerators and push metered handles.
- Deck mounted, metered push closing faucet with 5" integral spout, and 8" center x center supply connections.
- Adjustable run time from 5 to 20 seconds, 2.2 gpm

Model No.	Description	Order No.
404V-665	8" widespread lavatory faucet	<a href="#">CE1127</a>



### Fully Adjustable from 6" to 26" Faucet

- Vandal-resistant aerators supplying 2 gpm of water.
- Deck mounted, handicap handle manual closing faucet with 5" cast brass spout and 2-1/2" standard lever handles.

Model No.	Description	Order No.
404-HZABCP	Fully adjustable, 6" to 26" faucet	<a href="#">CE1125</a>



786-CP

### Large gooseneck spout on 8" supply center

- Soft-flo aerator with 6" handicap blade handles
- Manual closing faucet with GN2B rigid/swing spout: 9.75" to top of spout; 5.375" from inlet to outlet projection.
- 8" center x center supply connections.

Model No.	Description	Order No.
786-CP	8" widespread lavatory faucet	<a href="#">CE1200</a>

## Service Sink Assemblies for the Building Maintenance Professional



911-IS

Wall Mounted Vacuum Breakers



911

**Chicago Faucet 911** series service sink assemblies are wall mounted units where the vacuum breaker is separate from the actual faucet.

Model 911-IS has integral service stops on each of the hot and cold valves to allow for easy handle cartridge replacement. Model 911 does not have the integral service stops. All models have:

- 8" fixed supply centers.
- 5-3/4" rigid spout with 3/4" male hose thread and pail hook, wall flange and support rod.
- 1/2" NPT female thread inlets.
- Chrome plated, brass construction.
- 3" cross handles
- Slow compression operating cartridges.



Integral valve stops for easy cartridge repair



NO integral valve checks



Tear Drop Wall Escutcheons



Standard Wall Escutcheons

End of Spout Pail Hooks

Model No.	Description	Order No.
911-IS	With integral service stops	<a href="#">CE1247C</a>
911	Without integral service stops	<a href="#">CE1247D</a>

# Chicago Faucets for Service Sinks and More!

## Great Service Sink Faucets for the Building Maintenance Professional



### The Popular Service Faucet

- Wall mounted with adjustable supply arms from 7<sup>5</sup>/<sub>8</sub>" to 8<sup>3</sup>/<sub>8</sub>" centers.
- 3/4" male hose connection and pail hanger on 5" vacuum breaker spout & wall brace.
- Integral supply stops to shut-off water for faucet repair, and 1/2" female union nut inlets.



### Choose from Top-Supply (shown) or Bottom-Supply Connection Service Faucet

- Wall mounted with ceiling or floor supply connections with 6" center-to-center connections.
- 3/4" male hose connection and pail hanger on 5" vacuum breaker spout & wall brace.
- 1/2" female union nut inlets.
- Choose from polished chrome plated or rough chrome plated finishes.

Model No.	Description	Order No.
897-CP	Faucet with polished chrome finish	<a href="#">CE1245</a>
897-RCF	Faucet with rough chrome finish	<a href="#">CE1244</a>

Model No.	Description	Order No.
835-CP	Top supply faucet, polished chrome	<a href="#">CE1224A</a>
835-SFB	Bottom supply, polished chrome	<a href="#">CE1224C</a>
835-RCF	Top supply, rough chrome finish	<a href="#">CE1224B</a>

### Wide ranging adjustable supply arms make this one a BIG seller!

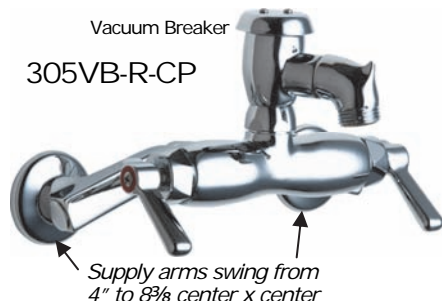

- Wall mounted with adjustable supply arms from 4" to 8<sup>3</sup>/<sub>8</sub>" centers.
- 3/4" male hose connection and pail hanger on 2" vacuum breaker spout
- Integral supply stops ("R") to shut-off water for faucet repair, and 1/2" female union nut inlets.

Model No.	Description	Order No.
<b>Faucets with "R" Integral Stop supply arms, polished chrome</b>		
305VB-R-CP	Faucet with vacuum breaker	<a href="#">CE1053</a>
305-R-CP	Faucet without vacuum breaker	<a href="#">CE1051</a>
<b>Faucets without type "R" Integral Stop supply arms</b>		
305-RCF	Faucet with rough chrome finish	<a href="#">CE1045</a>
305-CP	Faucet with polished chrome finish	<a href="#">CE1050</a>
305-VB	Polished chrome & vacuum breaker	<a href="#">CE1052</a>



### Inside and Outside Sill Faucets

- Model 952 for inside install; Model 998 is rough chrome plated for outside installation.
- Choose from 1/2" or 3/4" female pipe connection
- Built-in vacuum breaker & hose connection on spout.

Model No.	Description	Order No.
952-1/2	Polished chrome finish, 1/2" pipe	<a href="#">CE1253C</a>
952-3/4	Polished chrome finish, 3/4" pipe	<a href="#">CE1254</a>
998-1/2	Rough chrome finish, 1/2" pipe	<a href="#">CE1254H</a>
998-3/4	Rough chrome finish, 3/4" pipe	<a href="#">CE1254J</a>



### Chrome Plated Vacuum Breaker & Kit

Model No.	Description	Order No.
893-CP	3/8" vacuum breaker	<a href="#">CE1235</a>
892G-CP	1/2" concealed vac. breaker	<a href="#">CE1231</a>
892-CP	1/2" vacuum breaker	<a href="#">CE1230</a>
Repair Kit	Internal "guts" to repair a failed vacuum breaker	<a href="#">CF1320</a>

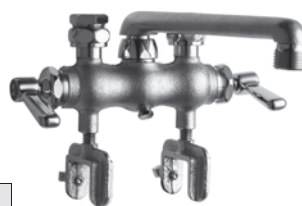

### Laundry Tub Faucet

- Top 1/2" pipe supply lines on 3-3/8" centers, and tightening brackets for laundry tub.
- 6" swing spout with hose connection.
- Rough chrome plated finish for long wear.

Model No.	Description	Order No.
686-RCF	Top supply laundry tub faucet	<a href="#">CE1157</a>



# Chicago Faucets for Service Sinks and More!

## Great Sink Faucets for Commercial and Institutional Facilities

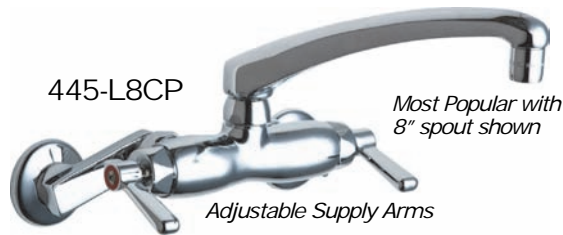

### Back-mounted faucet with adjustable supply arms

- Choose from 6", 8", 9", 12" and 15" one-piece swing spouts.
- Adjustable supply arms from 4" to 8<sup>3</sup>/<sub>8</sub>" center x center.
- 1/2" female union nut inlets. Softflo 2.2 gpm aerator.
- Polished chrome plated finish.

### Double-jointed spouts mean LONG reach capabilities!

- Choose from 13" or 18" long double-jointed (DJ) spouts.
- Adjustable supply arms from 4" to 8<sup>3</sup>/<sub>8</sub>" center x center.
- 1/2" female union nut inlets. Softflo 2.2 gpm aerator.
- Polished chrome plated finish.

Model No.	Description	Order No.
445-CP	Back mount faucet, 6" spout	<a href="#">CE1140</a>
445-L8CP	Back mount faucet, 8" spout	<a href="#">CE1142+CF1405</a>
445-L9CP	Back mount faucet, 9" spout	<a href="#">CE1142+CF1410</a>
445-L12CP	Back mount faucet, 12" spout	<a href="#">CE1142+CF1412</a>
445-L15CP	Back mount faucet, 15" spout	<a href="#">CE1142+CF1413</a>
445-LSSPT	Faucet body <u>less</u> the spout	<a href="#">CE1142</a>

Model No.	Description	Order No.
445-DJ13	Faucet with 13" DJ spout	<a href="#">CE1141</a>
445-DJ18	Faucet with 18" DJ spout	<a href="#">CE1142+CF1330</a>



### Back mount faucet on adjustable supply arms

- Adjustable supply arms from 7<sup>1</sup>/<sub>4</sub>" to 8<sup>3</sup>/<sub>8</sub>" center x center.
- Choose from 6", 8", 9" and 12" one-piece swing spouts.
- 1/2" female union nut inlets.
- Polished chrome plated finish and Softflo aerator.

Model No.	Description	Order No.
540-LD	Back mount faucet, 6" spout	<a href="#">CE1145</a>
540-LD8	Faucet with 8" spout	<a href="#">CE1146+CF1405</a>
540-LD9	Faucet with 9" spout	<a href="#">CE1146+CF1410</a>
540-LD12	Faucet with 12" spout	<a href="#">CE1146+CF1412</a>
540-LDLSPT	Faucet <u>less</u> spout	<a href="#">CE1146</a>
540-ABCP	540-LD <b>with soap dish</b> , top faucet mounted, 6" spout	<a href="#">CE1145A</a>

<p>631-CP</p>	<b>Like 540-LD (above) with Gooseneck Spout and wrist-blade handles</b>	
	<ul style="list-style-type: none"> <li>■ Model 631-CP as shown; Model 631-R-CP has integral supply stops in supply arms. Chrome plated.</li> <li>■ 1/2" female union inlets.</li> </ul>	
631-CP	Faucet as shown above	<a href="#">CE1154A</a>
631-R-CP	With integral supply stops	<a href="#">CE1154</a>

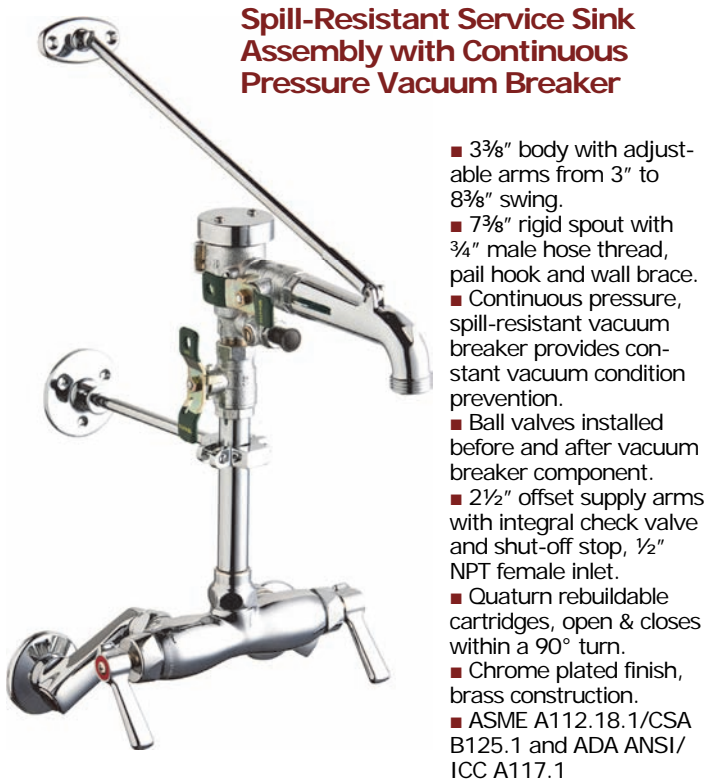

Model No.	Description	Order No.
445-PVBCP	Spill-Resistant Service Sink Faucet	<a href="#">CE1142A</a>

# Chicago Faucets for Kitchens and Rest Rooms

## Manually Operated Faucets for your Kitchens and Rest Rooms

- Solid cast-brass, chrome-plated construction for long-lasting use in commercial and institutional applications. ■ Most faucets utilize a standard E-12 faucet aerator (3/16" - 27 female thread connections), providing a soft flow of water and resistance to mineral build-up. ■ All faucets are ADA approved (only five pounds of pressure required to activate) unless otherwise noted.
- All faucets have a standard 1/2" NPSM coupling nut for connection to either a 3/8" or 1/2" flexible supply riser.



### Single handle for Kitchens

- Deck mounted, with or without base. 10" swing chrome spout.
- Chrome plated faucets with No. 665 "MVP" self-closing valve and repairable cartridge.
- No. E-12 standard soft-flow aerator.



### Single handle for Lavatories

- Deck mounted, manually operated lever handle faucet with 4-3/4" integral spout.
- Chrome plated faucets with ceramic mixing cartridge and temperature limit stop.
- No. E-12 standard soft-flow aerator.

Model No.	Description	Order No.
2300	Lever handle faucet less deck plate	<a href="#">CE1370</a>
2300-8	Lever handle faucet with 8" deck plate	<a href="#">CE1395</a>
2301-8	2300-8, but includes spray assembly	<a href="#">CE1396</a>

Model No.	Description	Order No.
2200	Manual lever handle, no pop-up	<a href="#">CE1350</a>
2200-4VPP	Like 2200-4 but with vandal resistant chrome deck plate. No pop-up.	<a href="#">CE1362</a>

### Gentle Rinse Faucet



- Deck mounted, single-handle self-closing faucet with 4-1/8" integral spout.
- Chrome plated faucets with No. 665 "MVP" self-closing valve adjustable from 2 to 15 seconds
- Choose from E-15 spray outlet (shown), gently sprays soap from hands, or the standard E-12 soft-flow 2.0 gpm aerator.

Model No.	Description	Order No.
807-E12-665PSHCP	Indexed "Push" with E12	<a href="#">CE1221B</a>
807-665PSHCP	Indexed "Push" with E15	<a href="#">CE1221A</a>

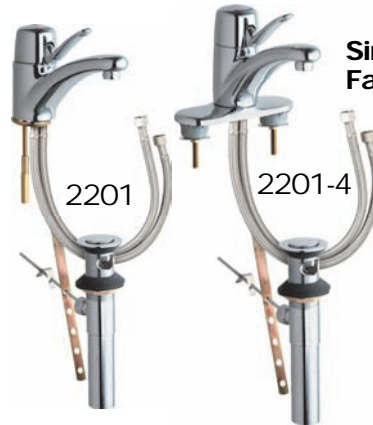

### Single handle Lavatory Faucets with pop-ups

- Deck mounted, manually operated lever handle faucet with 4-3/4" integral spout and pop-up for drain closing.
- Chrome plated faucets with ceramic mixing cartridge and temperature limit stop.
- No. E-12 standard soft-flow aerator.

Model No.	Description	Order No.
2201	Lever handle w/pop-up	<a href="#">CE1365</a>
2200-4	With 4" chrome deck plate to cover exposed holes. No pop-up.	<a href="#">CE1360</a>
2201-4	Like 2200-4, with 4" chrome deck plate and includes 1 1/4" pop-up drain	<a href="#">CE1366</a>

### Grid Drain for Lavatories



- Non-removable grid strain drain assembly for commercial and institutional applications.
- 2-1/4" diameter drain top. Overall length, 6-5/8"
- Select from 1-1/4" O.D. or 1-1/2" O.D. chrome plated brass tubing tailpiece.

Model No.	Description	Order No.
327-ACP	Grid drain, 1-1/4" OD tubing	<a href="#">CE1065</a>
	Grid drain, 1-1/2" OD tubing	<a href="#">CE1070</a>

### Replacement Pop-Up Assemblies

- 2-1/4" diameter drain top. Overall length of drain component, 6-5/8"
- Select from 1-1/4" O.D. or 1-1/2" O.D. chrome plated brass tubing.

Model No.	Description	Order No.
226-ACP	1-1/4" OD tubing	<a href="#">CE1030</a>
	1-1/2" OD tubing	<a href="#">CE1035</a>



# Chicago Faucets for a Variety of Sink Applications

## Great Sink Faucets for Commercial and Institutional Facilities



### Heavy-duty for Years of Reliable Use!

- Comes standard with the 9" heavy-duty, one-piece brass swing spout, Softflo aerator. With or without spray
- 8" center x center water supplies.
- 1/2" coupling supply nuts for 3/8" or 1/2" water supply risers
- Pressure compensating to 2.2 gallons per minute.
- Polished chrome plated finish.

Model No.	Description	Order No.
1100-CP	Heavy-duty commercial kitchen faucet	<a href="#">CE1250</a>
1100-LSSPT	1100-CP <u>without</u> a spout	<a href="#">CE1249H</a>
1102-CP	1100-CP but <u>with</u> a spray assembly	<a href="#">CE1250A</a>

### Concealed Deck Mounted Kitchen Faucets

- Choose from models with 8" swing spouts or 8" gooseneck spouts that can be mounted rigid (non-moving spout) or swing.
- 8" center x center water supplies.
- 1/2" coupling supply nuts for 3/8" or 1/2" water supply risers
- Pressure compensating to 2.2 gallons per minute.
- Polished chrome plated finish.

Model No.	Description	Order No.
200A-CP	Faucet with spray assembly	<a href="#">CE1036A</a>
200A-LSSPT	200A-CP <u>without</u> spout	<a href="#">CE1036</a>
201A-CP	200A-CP <u>without</u> spray assembly	<a href="#">CE1037A</a>
201A-LSSPT	201A-CP <u>without</u> spout	<a href="#">CE1037</a>
201A-GN8A-317	201A-CP with 4" wrist blade handles and 8" gooseneck spout	<a href="#">CE1038</a>

### Single-Hole, single-handle cold water faucets



- Single cold water supply faucet
- Choose from 9" tall x 5.5" deep gooseneck faucet (No. 350) or 6" swing spout (No. 349) models.
- The swing spout can be converted to "non-swinging" during installation.
- 1/2" coupling supply nuts for 3/8" or 1/2" water supply risers.
- Pressure compensating to 2.2 gallons per minute.
- Polished chrome plated finish.

Model No.	Description	Order No.
349	With gooseneck spout	<a href="#">CE1094</a>
349LS	349 less spout	<a href="#">CE1093</a>
350	With swing spout	<a href="#">CE1095</a>

### Swing spout faucet on 4" supply centers

- Two-handle, swing spout (convertible to rigid) faucet.
- Choose from 6" or 8" one-piece swing spout, or double-jointed 13" swing spout.
- 1/2" coupling supply nuts for 3/8" or 1/2" water supply risers.



Model No.	Description	Order No.
891	Faucet with 6" spout	<a href="#">CE1225</a>
891-L8	Faucet with 8" spout	<a href="#">CE1239+CF1405</a>
891-DJ13	With 13" double-jointed spout	<a href="#">CE1239+CF1325</a>

# Chicago Faucets for a Variety of Sink Applications



**Gooseneck Lavatory and Bar faucets, 4" supply centers. Select from pop-up or those without pop-ups.**

- Two-handle faucet on 4" water supply centers
- Choose from models with a 1¼" pop-up for bathroom drains; standard 2½" handles or 4" wrist-blade handles.
- The 8" tall x 3½" deep gooseneck spout can be converted to "non-swinging" during installation.
- 1/2" coupling supply nuts for 3/8" or 1/2" water supply risers.
- Pressure compensating to 2.2 gallons per minute.
- Polished chrome plated finish.



Model No.	Description	Order No.
894-CP	Faucet with pop-up, standard 2½" handles	<a href="#">CE1236</a>
894-317CP	894-CP with pop-up, 4" wrist blade handles	<a href="#">CE1236A</a>
895-CP	Faucet less pop-up, standard 2½" handles	<a href="#">CE1240</a>
895-317CP	895-CP, less pop-up, 4" wrist blade handles	<a href="#">CE1241</a>
895-LSSPT	895-CP, less pop-up and spout, std. handles	<a href="#">CE1239</a>
Pop-Up Assembly	Pop-up assembly with 1¼" OD tailpiece	<a href="#">CE1030</a>
	Pop-up assembly with 1½" OD tailpiece	<a href="#">CE1035</a>

**For single-hole lavatories, bars and other sinks. Select from two different supply connection styles.**

- Two-handle faucet on 3½" water supply centers or 3/8" O.D. flexible stainless supply lines.
- Choose from models with a 9" high x 5" deep gooseneck spout or a 6" swing spout.
- The gooseneck spout can be converted to a "non-swinging" rigid style during installation.
- 1/2" coupling supply nuts on the model 50T or 51T for 3/8" or 1/2" water supply risers.
- Pressure compensating to 2.2 gallons per minute.
- Polished chrome plated finish.

Model No.	Description	Order No.
50-CP	Faucet with gooseneck spout and 3/8" O.D. flexible stainless supply lines	<a href="#">CE1020</a>
50-CP-LSSPT	50-CP, like above <u>without</u> a spout	<a href="#">CE1021</a>
50-TCP	With gooseneck spout and yoke mixing valve with 1/2" coupling nuts	<a href="#">CE1022</a>
51-CP	Faucet with 6" swing spout and 3/8" O.D. flexible stainless supply lines	<a href="#">CE1025</a>
51-T	51 with 6" swing spout and yoke mixing valve with 1/2" coupling nuts	<a href="#">CE1024</a>

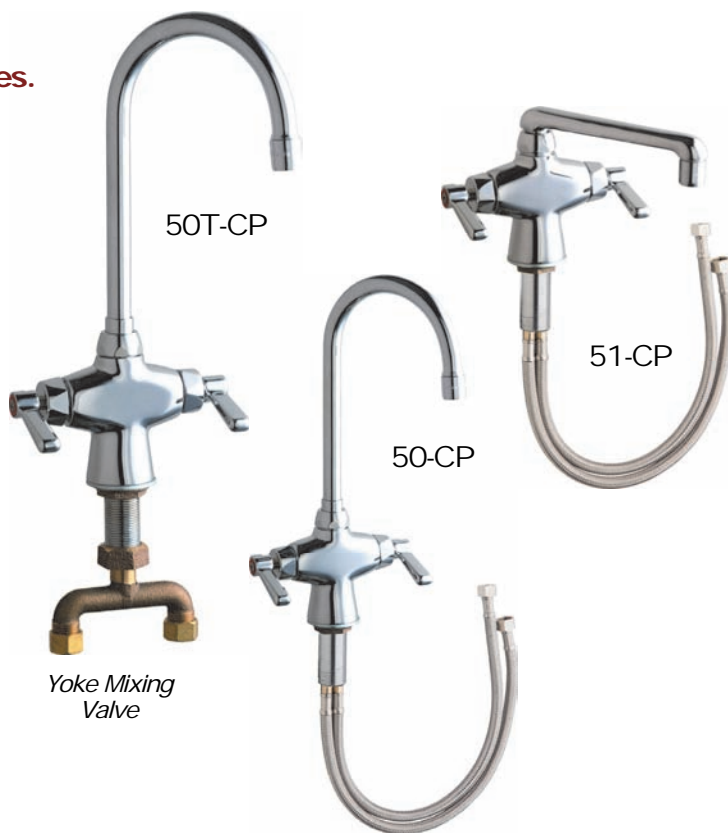

# Chicago Faucet Bubblers and Flush Valves

## Water Bubblers



- Select from the 748-665T with a long neck (3.625" from base to water spout) or the 748-665 with a short neck (2.0" from base to water spout).
- 1/2" coupling supply nuts for 3/8" or 1/2" water supply risers.
- Produces 0.7 gallons per minute of steady-stream water flow.
- Easily install next to counter mounted sinks of all kinds.
- Polished chrome plated finish for long-lasting good looks!

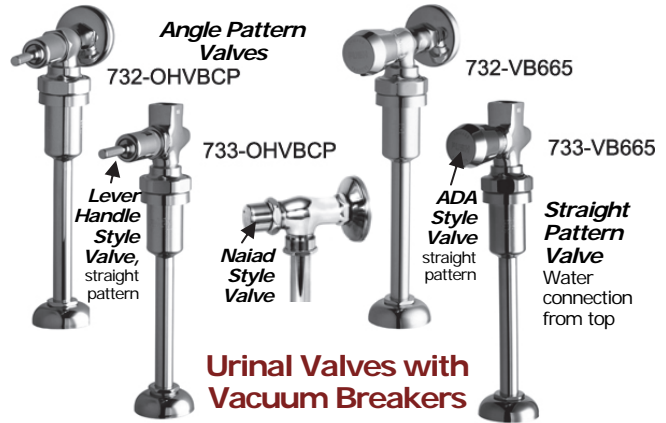

## Urinal Valves with Vacuum Breakers

- Select from straight pattern piping (models 733-) or the angle pattern piping (models 732-) styles.
- Select lever handle or push-in (Naiad or ADA) activation.
- 3/4" OD x 8" long tailpieces come with or without vacuum breakers (vacuum breaker style unless shown otherwise).
- All valves are chrome plated and have a 1/2" female pipe inlet for connection to the water supply.
- Replacement valves only — Order from table at page bottom.

Model No.	Description	Order No.
748-665T	Water bubbler with Long Neck	<a href="#">CE1190</a>
748-665	Water bubbler with Short Neck	<a href="#">CE1191</a>

Model No.	Piping Style	Description	Order No.
732-OHVB	Angle	With lever handle flusher	<a href="#">CE1171</a>
732-VB665		With ADA push-in valve	<a href="#">CE1177</a>
732-VB		With "Naiad" push-in valve	<a href="#">CE1170</a>
732-OHCP		Without vacuum breaker	<a href="#">CE1169Z</a>
733-OHVB	Straight	With lever handle flusher	<a href="#">CE1180A</a>
733-VB665		With ADA push-in valve	<a href="#">CE1179</a>
733-VB		With "Naiad" push-in valve	<a href="#">CE1180</a>
733-OHCP		Without vacuum breaker	<a href="#">CE1178</a>

## Convert old fashion water fountains to Easy-to-Maintain Bubbler Head Units



Your old white china water fountains come with a separate water pressure regulator and bubbler head. When the pressure regulator goes bad, you've got a mess on your hands — you need to take the entire water fountain off the wall to repair the water fountain! Forget that noise!

### Here's the Easy Way . . .

Remove the old water fountain handle and replace it with the Water Bubbler Kit: Includes bubbler head with built-in water pressure cartridge, supply line and hole-cover for old faucet handle "hole." Future repairs will be a breeze!

#### KIT CONTAINS:

- Chrome plated brass bubbler head with lead-free cartridges
- 1/2" X 3/8" X 3-1/2" inlet shank
- Polished stainless steel flange, Rosette, Locknut & coupling nut
- 1-3/4" handle hole cover ■ 3/8" x 12" supply line

Model No.	Description	Order No.
2197	Complete Bubbler Kit with accessories	<a href="#">CD1020</a>
K-361	Replacement water regulating cartridge	<a href="#">CD1025</a>
2188	Extra-long inlet shank, 1/2" x 3/8" x 4 1/2"	<a href="#">CD1021</a>

#### Replacement Components

734	Replacement vacuum breaker tailpiece	<a href="#">CE1185</a>
892-032	Vacuum breaker repair kit	<a href="#">CF1320</a>
333X-SLO	Replacement Naiad cartridge	<a href="#">CF1190</a>
665RK	Replacement ADA cartridge	<a href="#">CF1417</a>

## Old-Style Urinal Valves Only

Traditional, old style urinal flow control valves only.

- Available in straight or angle patterns.
- Chrome plated.
- 1/2" pipe connections.
- Made by Pasco Mfg.

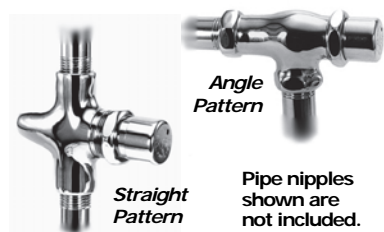

Model No.	Description	Order No.
732-NAIAD	Straight-pattern Naiad-like Valve only	<a href="#">GU2118A</a>
733-NAIAD	Angle-pattern Naiad-like Valve only	<a href="#">GU2118B</a>

# Chicago Faucet Showers, Pre-Rinse & Twist Drains

## Shower Heads and Assemblies

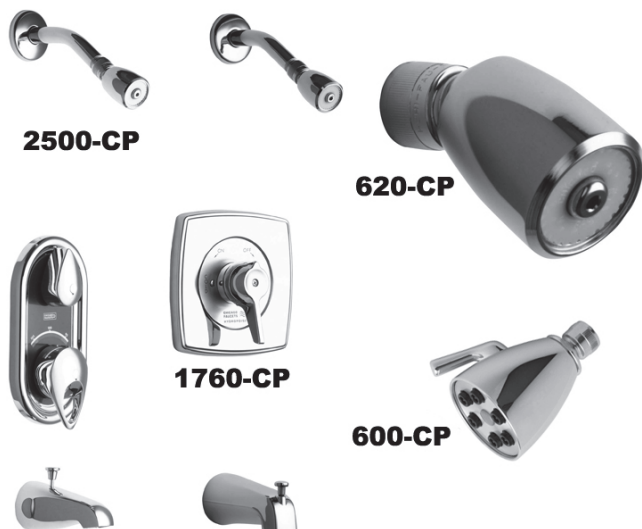

### Solid Chrome Brass, Chrome Shower Heads

Looking for a heavy-duty, long-lasting shower head? Choose either the model 620-CP with standard 2.0 gpm flow, integral flow control and 1/2" female pipe connection or the model 600-CP with an external flow control and adjustable spray pattern.

### Standard and Temperature Mixing Showers

Choose from the standard model 1760-CP or the thermostatic pressure balancing model 2500-CP:

- Model 1760 pressure balancing shower assembly. 1/2" copper water supply inlets. 1/2" female pipe outlets. Available in shower only or shower and tub diverter spout models. Maximum 2.5 gpm water flow.
- Model 2500 pressure and temperature balancing shower assembly. Maximum temperature stop factory set to 120° F. 1/2" copper water supply inlets. 1/2" female pipe outlets. Available in shower only or shower & tub diverter spout models. Maximum 2.5 gpm water flow.
- Integral check & service stops - Easy Repair!

Model No.	Description	Order No.
620-CP	Heavy-duty shower head, chrome plated	CE1150
620-ACP	Heavy-duty shower head, chrome plated with shower head arm	CE1150A
600-CP	Adjustable spray head, chrome plated	CE1149M
1760-CP	Pressure balancing shower assembly with tub diverter spout	CE1320
1762	Pressure balancing shower assembly <u>without</u> tub diverter spout	CE1322A
2500-CP	Pressure/Temperature balancing shower assembly with tub diverter spout	CE1398A
2502	Pressure/Temperature balancing shower assembly <u>without</u> tub diverter spout	CE1398B

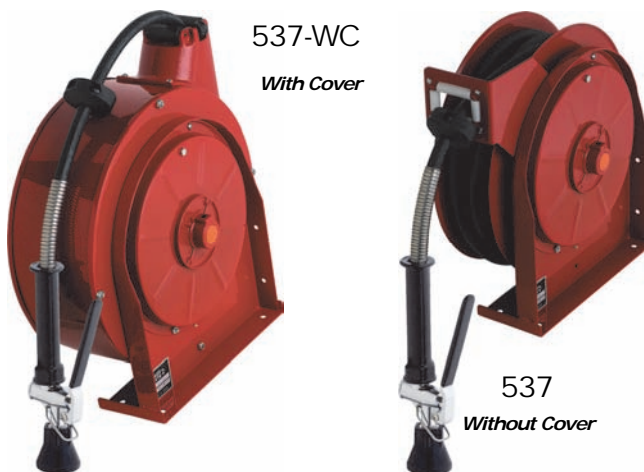

### Pre-Rinse Spray on 35 foot Hose Reel

- Select covered (537-WC) or uncovered (537) hose reel.
- 35 feet of 3/8" ID rubber hose on retractable hose reel.
- No. 80 straight-pattern spray head
- 3/8" female pipe size inlet
- Hose bumper, hose spring and push-lock hose end.
- Model 548 (not shown) is the Model 537 with stainless steel hose reel housing, main shaft and swivel.

Model No.	Description	Order No.
537	Pre-rinse on hose reel, 35' hose	CE1144B
537-WC	537 with hose reel cover	CE1144A
548	537, stainless steel components	CE1146B

### Twist-Lever Operated Kitchen Drains

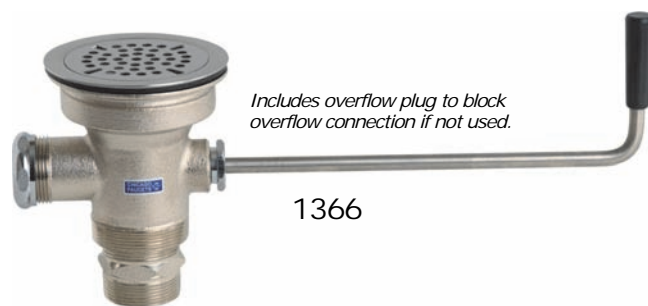

- Twist operated for 3 1/2" sink drain.
- Drain outlet is standard 2" male pipe, includes 1 1/2" adapter.
- 1 1/4" overflow outlet at back of drain.
- Includes plug to block the back overflow connection if this overflow connection will not be used.

Model	Description	Order No.
1366	Twist operated drain with overflow	CE1300
<b>Repair Parts</b>		
1366-033	O-Ring and stem valve stopper	CF1500
1366-004	Strainer plate assembly	CF1510
1366-005	Strainer plate only	CF1515

# Chicago Faucet Pre-Rinse Units for Kitchens



Model No.	Pre-Rinse Unit Descriptions	Order No.
509-GC	Wall mounted pot filler with pre-rinse spray valve. Uses an L9 swing spout, No. 81 self-closing angled spray valve & 23" chrome pipe riser. Also utilizes the 613A Add-A-Faucet. The 7¼" x 8¾" adjustable supply arms have Integral Checks. 60" flexible stainless steel hose with insulated handle. 1/2" pipe size female inlets.	<a href="#">CE1143</a>
510-GC	Wall mounted pre-rinse uses a No. 80 self-closing straight spray valve and 23" chrome pipe riser. The water supply arms with Integral Checks adjust to 7.25" x 8.75" supply centers. 44" flexible stainless steel hose with insulated handle. 1/2" pipe size female inlets.	<a href="#">CE1144</a>
512-GC	Wall Mounted Kettle Faucet on adjustable 7.25" x 8.75" supply centers. 44" flexible stainless steel hose. Utilizes an atmospheric vacuum breaker spout, No. 84 self-closing pot filler valve. Manually operated 369 lever handles. 1/2" pipe size female inlets.	<a href="#">CE1044A</a>
613A	Need to add a spout to your pre-rinse unit? You're in luck! Use the Add-A-Faucet. Comes with L9 swing spout and E1. Controlled with one 369 lever handle to turn on/off. <i>See the Add-A-Spout on the Model 509GC</i>	<a href="#">CE1152</a>
919	Deck Mounted Pre-Rinse unit for single hole connection. 23" chrome plated pipe riser wall support and spring guide. Utilizes the No. 80-L water conserving spray valve and No. 369 lever handles. 44" flexible stainless steel hose with insulated handle. 1/4" male pipe size check tailpieces.	<a href="#">CE1249</a>
919-S	The Model 919 <u>without</u> faucet valve body. Includes the 23" pipe riser, hose, spring, valve & support.	<a href="#">CE1248</a>
923	Wall Mounted Pre-Rinse unit on adjustable 4" to 8.75" supply centers. 23" riser with wall support and spring guide. No. 80-L water conserving spray valve and No. 369 lever handles. 44" flexible stainless steel hose with insulated handle. 1/2" pipe size female inlets.	<a href="#">CE1253</a>

# Chicago Faucet Pre-Rinse Unit Repair Parts

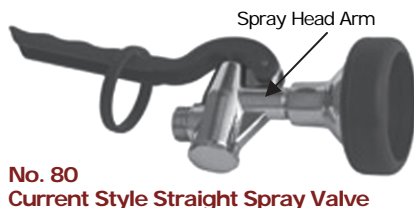
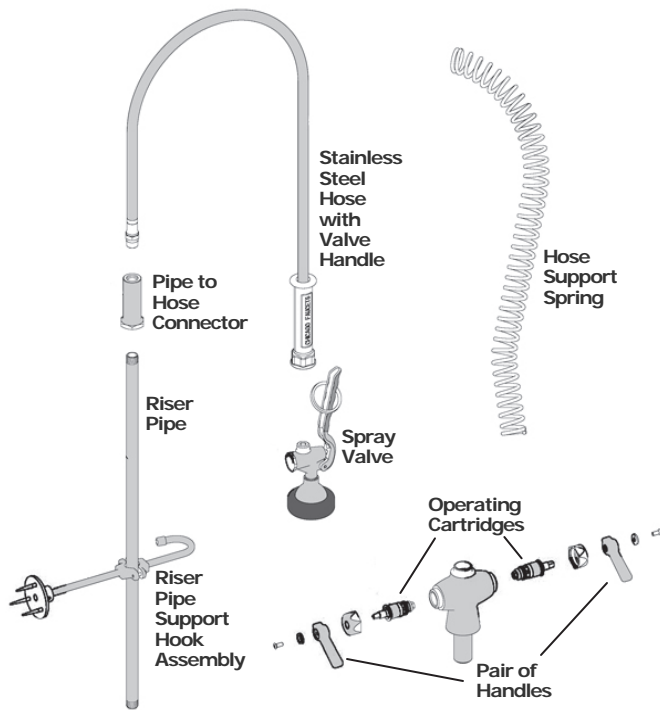

The No. 81 spray valve (not shown) is similar to the No. 80 except the spray head arm is not straight, but at a 45° angle.



**No. 80 Old Style Straight Spray Valve (Obsolete)**  
*Shown for reference purposes only.*

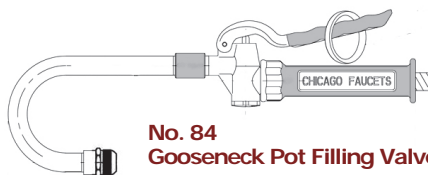

All hoses come with a built-in handle & adapters for connection to T&S and Fisher brands of pre-rinse units

Model No.	Description	Order No.
<b>Replacement Spray Valves</b>		
80	Self-closing, <u>straight pattern</u> pre-rinse valve assembly complete.	<a href="#">CE1028</a>
81	Self-closing, <u>45° angle pattern</u> pre-rinse valve assembly complete.	<a href="#">CE1028A</a>
84	Self-closing, <u>goose neck spout</u> pot filling valve.	<a href="#">CE1029B</a>
919-206K	Handle and adaptor that allows the OLD style (before 2001) Chicago hoses to fit on the current style spray valves.	<a href="#">CF1323H</a>
<b>Repair cartridges for spray valves and faucet body</b>		
919X	Replacement spray valve cartridge for all OLD models of Chicago Spray Valves.	<a href="#">CF1323</a>
919-130	Replacement spray valve cartridge for all NEW models of Chicago Spray Valves.	<a href="#">CF1323B</a>
1-100XT	Faucet body operating cartridge, Hot.	<a href="#">CF1063</a>
1-099XT	Faucet body operating cartridge, Cold.	<a href="#">CF1057</a>
<b>Replacement Faucet Body Handles</b>		
369	Pair of hot/cold handles for faucet bodies	<a href="#">CE1100</a>
<b>Replacement Spring for Hose Support</b>		
919-014	Spring for hose support.	<a href="#">CF1323A</a>
<b>Replacement Rubber Bumpers for Spray Valves</b>		
919-235	Replacement rubber bumper with spray head for OLD model 80 valves.	<a href="#">CF1323F</a>
919-150	Replacement rubber bumper with spray head for NEW model 80 valves.	<a href="#">CF1323C</a>
<b>Replacement Hoses (includes T&amp;S and Fischer adapters)</b>		
83-29	29" stainless steel replacement hose with built-in valve handle.	<a href="#">CE1027B</a>
83-44	44" stainless steel replacement hose with built-in valve handle.	<a href="#">CE1027C</a>
83-58	58" stainless steel replacement hose with built-in valve handle.	<a href="#">CE1027D</a>
83-77	77" stainless steel replacement hose with built-in valve handle.	<a href="#">CE1027E</a>
919-143	Replacement gaskets for hose ends.	<a href="#">CF1323D</a>



# Chicago Faucet for Health Care Applications

## Faucets and Accessories for Health Care Facilities

### Hospital Knee Valves & Spouts



### Bed Pan Washer with Stop Lever Spray Handle

- Bed Pan Cleaner with atmospheric vacuum breaker. Model 809-777-21
- Angle spray nozzle with stop lever valve.
- Single On/Off cross handle.
- Slow compression operating cartridge.
- White vinyl hose with hook to hold the spray head.
- Separate loose key service stop prevents unwanted use.
- 1/2" NPT female inlet connection.
- Rubber bound spray outlet protects spray head from damage.



#### The hospital knee valves are available in two styles:

- The Model **745-VO** which comes with a white aluminum wall bracket for wall mounting, and the Model **745-CC-VO** which comes with a drilled flange for chair carrier mounting.
- Both models have 699 straight stops & 1.6 gpm flow control.

#### The goose neck spouts also come in two styles:

- The Model **626-E3** is deck mounted with a GN2A 5-3/8" spout and spout base; the Model **629-E3** is wall mounted with a GN1A 3-1/2" spout.
- Both spouts have 1/2" flanged female inlets with coupling nut and E3, 2.0 gpm aerators.

Model No.	Description	Order No.
809	Complete bed pan washer	<a href="#">CE1223</a>
777-21KJK	Replacement spray valve with stop lever assembly	<a href="#">CE1193A</a>

Model No.	Description	Order No.
745-VO	Knee valve for wall mounting	<a href="#">CE1186</a>
745-CC-VO	Knee valve for chair carrier mounting	<a href="#">CE1187</a>
626-E3	Deck mounted gooseneck spout	<a href="#">CE1153B</a>
629-E3	Wall mounted gooseneck spout	<a href="#">CE1153C</a>

### Hospital Pedal Valves

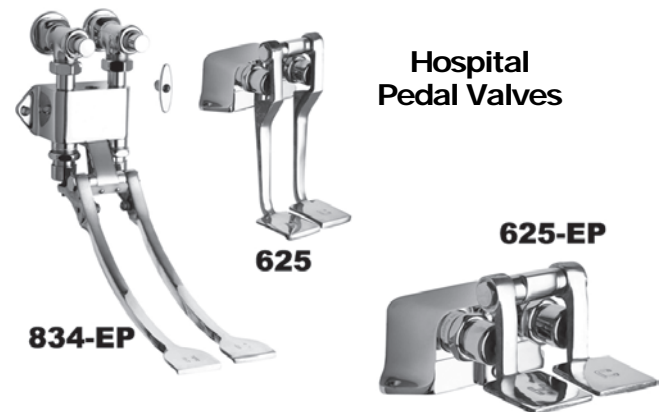

#### Heavy-duty for years of reliable use!

- Polished chrome plated delivering 2.0 gpm of water.
- Model 625 has 3" long pedals, 2 each 1/2" female pipe back inlets and one 3/8" female pipe back outlet.
- 625-LP is similar to 625 except it has 8" long pedals and is made for mounting on the base of cabinets 5.5" above the floor.
- Model 834-EP is the 14" long-leg, wall mounted pedal valve. Includes angle stops on 2.5" centers, one 3/8" female top outlet and two 3/8" female back inlets.



### Bed Pan Washer with Foot Controls

- Elevated Vacuum Breaker
- Spray Nozzle without Stop Valve
- 834-EP - Wall Mounted Pedal Valve
- NAIAD™ Self Closing Cartridge
- 4' White Vinyl Hose with Rubber Bound Spray Outlet
- Separate Loose Key Service Stops
- 1/2" NPT Female Inlets

Model No.	Description	Order No.
910-G	Bed Pan Washer	<a href="#">CE1247B</a>

Model No.	Description	Order No.
625	Double pedal valve, 3" long pedals	<a href="#">CE1153</a>
625-SLO	625 with slow-closing valve	<a href="#">CE1152B</a>
625-LP	625 with 8" long pedals	<a href="#">CE1153A</a>
834-EP	Double pedal valve, 14" long pedals	<a href="#">CE1224</a>

# Chicago Faucet Laboratory Faucets

## Laboratory Faucets and Fittings



Laboratory Faucets	Spout & Aerator Outlet	Order No.
926 deck mount, single handle, non-gooseneck spout	S6, E3	<a href="#">CE1250C</a>
926VB-E7 like 926 with vacuum breaker & serrated hose connect	L8BVB, E7	<a href="#">CE1250D</a>
927, like 928 but without the vacuum breaker spout	GN2B, E7	<a href="#">CE1250F</a>
928, single handle, vacuum breaker, deck mount	GN2BVB, E7	<a href="#">CE1251</a>
928VR, like 928 but made to be fully vandal resistant	GN2BVB, E7	<a href="#">CE1251A</a>
929 like the 930 but without a vacuum breaker on spout	GN2B, E7	<a href="#">CE1252</a>
930, two handle, vacuum breaker, deck mount	GN2BVB, E7	<a href="#">CE1252A</a>
930VR like 930 but made to be fully vandal resistant	GN2BVB, E7	<a href="#">CE1252B</a>
937, needle valve, 3/8" pipe connection, serrated hose connection	GN2BVB E7	<a href="#">CE1247</a>
938, wall mount, angle pattern, 1/2" flanged female inlet	1/2" Female E7	<a href="#">CE1252G</a>
939 same as 938 but with a 1/2" male inlet	1/2" Male E7	<a href="#">CE1252J</a>
942 adjustable 7/4 to 8 3/4 centers, wall mount, 2 handle	GN2B, E7	<a href="#">CE1252M</a>
943 same as 942 but with vacuum breaker gooseneck	GN2BVB, E7	<a href="#">CE1252P</a>
954 similar to 938, but with 3/8" female supply inlet	3/8" Female E7	<a href="#">CE1252R</a>
985B similar to 928, but with 3/8" female supply inlet	GN2B, E7	<a href="#">CE1254M</a>

## Remote Spouts, Valves and Fittings

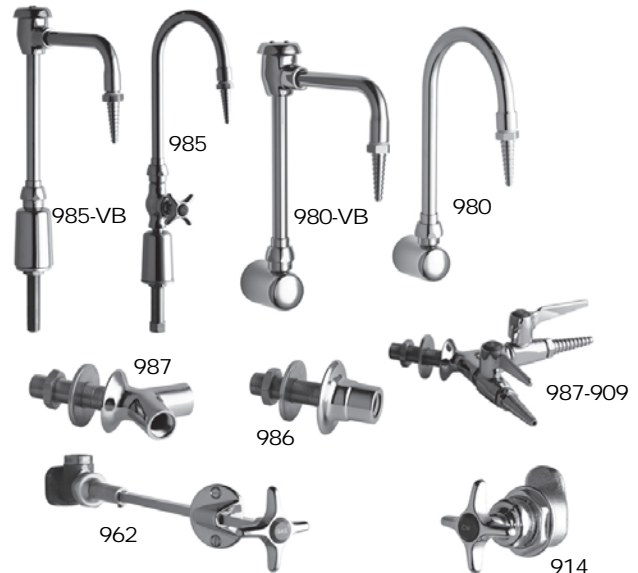

### Remote Control Valve Assemblies

Description	Usage	Repair Cartridge	Order No.
913 Panel Mount	All gases	962X	<a href="#">CE1246J</a>
913LH Panel Mount	All gases	962X	<a href="#">CE1246K</a>
914 Panel Mount	Water	217XTLH	<a href="#">CE1246L</a>
914LH Panel Mount	Water	217XTLH	<a href="#">CE1246M</a>
915 Panel Mount	Steam	937XST	<a href="#">CE1246N</a>
915LH Panel Mount	Steam	937XST	<a href="#">CE1246P</a>
962VO Angle	Water	217XTLH	<a href="#">CE1264D</a>
962VOA Angle	Water	217XTLH	<a href="#">CE1264E</a>
962VOG Angle	All gases	962X	<a href="#">CE1264F</a>
962VOG-205 Angle	All gases	962X	<a href="#">CE1264G</a>
962VOG-966 Angle	All gases	966X	<a href="#">CE1264H</a>
962VOG-966S Angle	All gases	966XSS	<a href="#">CE1264J</a>

### Remote Control Spout Assemblies & Fittings

Description	Mount	Inlet	Order No.
980-GN2B-E7 less mounting shank	Wall Turret	3/8"	<a href="#">CE1264K</a>
980-GN2BVB-E7 same as 980 but with vacuum breaker spout	Wall Turret	3/8"	<a href="#">CE1264L</a>
985A less mounting shank	Deck	3/8"	<a href="#">CE1254L</a>
985A-GN8BVB-E7 same as 985 but with vacuum breaker	Deck	3/8"	<a href="#">CE1254N</a>
986 wall flange & 3/8" x 2 5/8" inlet shank. 3/8" pipe connection.	Wall flange	3/8"	<a href="#">CE1254C</a>
987 "Y" wall flange with inlet shank. 3/8" pipe connection.	Wall flange	3/8"	<a href="#">CE1254V</a>
987-909 "Y" wall flange & 3/8" x 2 5/8" inlet shank, and two ball valve hose nozzles	Wall flange	3/8"	<a href="#">CE1254W</a>

# Chicago Faucet Accessories

## Laboratory Turrets & Hose Cocks



Turrets have 3/8" female outlet x 3/8" female inlet connections. The hose cocks have 3/8" male inlet connections for insertion into turrets. Hose cocks rated to either 100 psi or 40 psi. All have chrome plated finish.

Model No.	Description	Inlet	Outlet	Order No.
980	Single outlet turret	3/8" FIP	3/8" FIP	<a href="#">CE1254B</a>
981	Two 180° outlet turret	3/8" FIP	3/8" FIP	<a href="#">CE1254D</a>
982	Two 90° outlet turret	3/8" FIP	3/8" FIP	<a href="#">CE1254E</a>
983	Three 90° outlet turret	3/8" FIP	3/8" FIP	<a href="#">CE1254F</a>
984	Four 90° outlet turret	3/8" FIP	3/8" FIP	<a href="#">CE1254G</a>
986	Flange with shank	3/8" MIP	3/8" FIP	<a href="#">CE1254C</a>
901B	Hose Cock to 100psi; Gases	3/8" MIP	Hose	<a href="#">CE1245A</a>
909AG	Hose Cock, 40psi Indexed "AIR-GAS-VAC"	3/8" MIP	Hose	<a href="#">CE1246D</a>
909C	Like 909AG with built-in check	3/8" MIP	Hose	<a href="#">CE1246C</a>
937	Hose Cock, 40 psi; "WATER"	3/8" MIP	Hose	<a href="#">CE1247</a>
937CH	Hose Cock; 150psi; index GAS	3/8" MIP	Hose	<a href="#">CE1247A</a>

## Supplies, Inlet Shanks & Connectors

Many faucet requirements can be met by "substituting" supply connections for those regularly furnished. Any supply connection shown here will fit any faucet connection that is regularly furnished on any of them. Faucet bodies taking these supply connections have inlets on either a 3-3/8" or 8" centers.

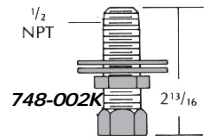

Description	Order No.
748-002K, 2-3/4" long shank; 1/2" male outlet, 1/2" coupling nut	<a href="#">CF1291Y</a>

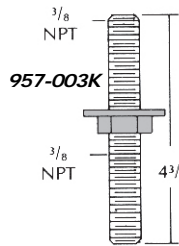

Description	Order No.
957-003K, 4-3/4" long shank, 3/8" npt inlet outlet	<a href="#">CF1324</a>
979-001K, 2-5/8" long	<a href="#">CF1324A</a>

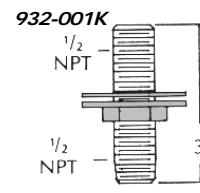

Description	Order No.
932-001K, 3" long shank 1/2" npt inlet & outlet	<a href="#">CF1323P</a>

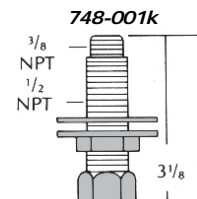

Description	Order No.
748-001K, 3-1/8" shank; 3/8" male outlet, 1/2" nut	<a href="#">CF1291X</a>
748-003K, 4-1/2" shank	<a href="#">CF1292</a>

## Supplies and Connectors



Description, All Chrome Plated	Order No.
261JKCP, Straight inlet supply arm, 1/2" pipe female Inlet, 2 1/8" diameter flange, 2 1/8" projection from wall	<a href="#">CF1103P</a>
WJKCP, Straight inlet supply arm, 1/2" pipe female inlet, 2 1/8" diameter flange, 2" projection from wall	<a href="#">CF1414P</a>
SSJKCP, Angle inlet supply arm, 1/2" pipe female inlet, 2 1/4" diameter flange, 2 1/4" projection from wall	<a href="#">CF1414D</a>
WXFJKCP, Straight inlet supply arm with 2 1/2" wall flange, 1/2" pipe female inlet, 2 1/8" projection from wall	<a href="#">CF1414M</a>
EX5JKCP, 5" Long Inlet Extension, 5" Projection from Wall, All Metal Construction, Chrome Plated	<a href="#">CF1354B</a>
EX2JKCP, 2" Short Inlet Extension, 2" Projection from Wall, All Metal Construction, Chrome Plated	<a href="#">CF1354C</a>

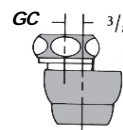

Description	Order No.
GC, 3/8" offset & 1/2" female inlet & integral check	<a href="#">CF1383A</a>
G, without check	<a href="#">CF1383</a>

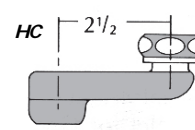

Description	Order No.
HC, 2-1/2" offset with check & 1/2" female inlet;	<a href="#">CF1383C</a>
H, without check	<a href="#">CF1383B</a>

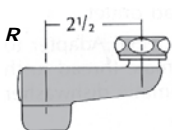

Description	Order No.
R, 2-1/2" offset with built-in shut-off & 1/2" female npt inlet	<a href="#">CF1414</a>

## Spout-to-Pipe Connection Adapters

Chrome plated spout adapters allow piping to be used between the faucet body and the spout.

- Choose the BA1, BA2 or BA3 adapter with spout connection on one end (select either 1/2" or 3/8" female pipe outlet for pipe connection).
- Next, depending on pipe size used, choose the SA1, SA2 or SA3 for connection to the end of your piping. This allows you to attach the spout to the end of the pipe. Used on all gooseneck, swing and vacuum breaker spouts.

Description	Order No.
BA1, faucet outlet body adapter, 1/2" female npt outlet, <u>union connection</u>	<a href="#">CF1331</a>
BA2, faucet outlet body adapter, 3/8" female outlet.	<a href="#">CF1332</a>
BA3, faucet outlet body adapter, 1/2" female outlet	<a href="#">CF1333</a>
SA1, straight spout inlet adapter, 1/2" female inlet	<a href="#">CF1414A</a>
SA2, 90° angle spout inlet adapter, 3/8" female inlet	<a href="#">CF1414B</a>
SA3, straight spout inlet adapter, 3/8" female inlet	<a href="#">CF1414C</a>

# Chicago Faucet Repair Parts

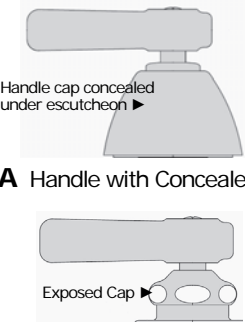

Handle cap concealed under escutcheon ▶

**A** Handle with Concealed cap

Exposed Cap ▶

**B** Handle with Exposed cap

**Determining the Cartridge you need:**

- Determine if your faucet requires a quarter-turn or full-turn to turn on and off.
- Next, determine if the cap is concealed under an escutcheon (**A**) or if the faucet handle cap is exposed (**B**).

Order replacement cartridges from the adjoining table.

## Hand Closing Cartridges

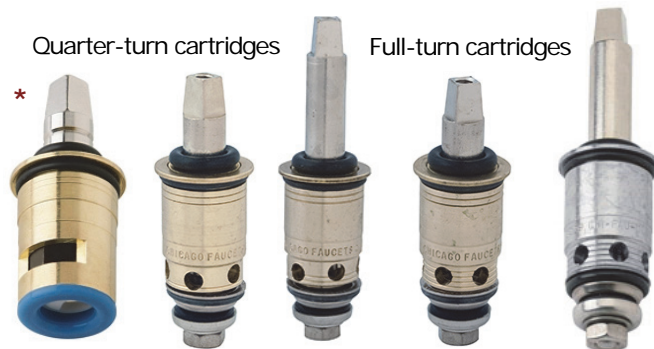

Right Hand	1-099XT	377XT-RH	217XT-RH	274XT-RH
Left Hand	1-100XT	377XT-LH	217XT-LH	274XT-LH
*New Ceramic 1-099XK = RH 1-100XK = LH	For Exposed cap faucets	For Concealed cap faucets	For Exposed cap faucets	For Concealed cap faucets

## Cartridge Repair Kit

Please order the "JIFFY Repair Kit" or the completely New replacement cartridges, as shown in the adjoining column. The JIFFY kit includes the "wearable" parts, packing, seat & seat washer to repair two (either Old or New) cartridges. Simply discard the parts you don't use.



### JIFFY REPAIR KIT

Description	Part No.	Qty.	For Old Style	For New Style	Order No.
<b>Jiffy Repair Kit</b> (contents below)					<b>CF1130</b>
Gasket	1-043	2	X		
Packing Washer	93-031	2	X		
Seat O-Ring	1-328	2		X	
Seat Washer	1-021	2	X	X	
Packing Washer	93-131	2		X	
Seal O-Ring	1-519	2	X	X	
Sleeve O-Ring	2-043	2		X	
Stem O-Ring	1-219	2		X	

## One-Minute Repair Kit

Contains hundreds of the essential repair parts you need to fix your leaking Hand Closing full-turn and quarter-turn Chicago Faucets: stems, bonnets, O-rings, washers and a whole lot more in a heavy-duty case.



Description	Order No.
One-Minute Repair Kit, Model 1273	<b>CF1324C</b>

## Self-Closing Stem Cartridges

*Close Immediately Upon Release*



These cartridges close immediately upon handle release. All Chicago Faucets can be converted to use these cartridges.

Description	Order No.
825X, for all self-closing lavatory and sink faucets with <b>concealed caps</b> (under escutcheon).	<b>CF1300</b>
826X, for self-closing faucets with <b>exposed cap</b> .	<b>CF1295</b>

# Chicago Faucet Repair Parts

## "Naiad" Self-Closing Cartridges



**333-X**      **625-X**  
**333-X-SLO**   **625-X-SLO**      **335-X**      **409-X**

The **335-X** and **409-X** are Tip-Tap, slow-closing operating cartridges. Adjustable running cycle from 2 to 15 seconds.

- No. 335-X is used on faucets with exposed caps.
- No. 409-X is used on faucets with concealed caps

The **333-X** and **625-X** are either immediate-closing or slow-closing (2 to 15 second cycle) operating cartridges.

- No. 333-X closes immediately after push-button released. Used on all the single basin model 333 faucets. The 333-X-SLO is similar to the 333-X, but with a slow-closing feature providing an adjustable running cycle from 2 to 15 seconds.
- No. 625-X closes immediately after push-button released. Used on all pedal valves. The 625-X-SLO is similar to the 625-X, but with a slow-closing feature providing an adjustable running cycle from 2 to 15 seconds. Note: The pedal valve models 625 and 628 use the 628X one-hole sleeve operating cartridge (Not shown below — special factory order).

Description	Order No.
333-X, cartridge for 333 basin faucets, "PUSH"	<b>CF1185</b>
333-X, same as above but indexed "HOT"	<b>CF1186</b>
333-X, same as above but indexed "COLD"	<b>CF1187</b>
625-X, standard push button cartridge for pedal valves <u>except</u> models 625 and 628	<b>CF1264F</b>
333-X SLO, slow closing push button cartridge for exposed cap installations. Adjustable running time from 2 to 15 seconds. Indexed "HOT"	<b>CF1188</b>
333-X-SLO, same as above but indexed "COLD"	<b>CF1189</b>
333-X-SLO, same as above but indexed "PUSH"	<b>CF1190</b>
625-X-SLO, slow closing push button cartridge for pedal valve installations. Adjustable running time from 2 to 15 seconds	<b>CF1264F</b>
335-X, slow closing "Tip-Tap" oscillating handle cartridge for exposed cap installations. Adjustable running time — 2 to 15 second	<b>CF1200</b>
409-X, slow closing "Tip-Tap" oscillating handle cartridge for concealed cap installations. Adjustable running time — 2 to 15 second	<b>CF1225</b>

## MVP Self-Closing Cartridges

Whenever your old Naiad self-closing cartridges need repair, do the smart thing — Replace them with these "American with Disabilities Act" approved self-closing metering cartridges. The MVP metering cartridge features adjustable running water time cycles from 2 to 15 seconds. The timing cycle is adjustable via an Allen wrench on the handle. The 665 has a solid chrome plated cast brass handle. New 665 cartridges come pre-assembled with the components shown in the image to the right.



**Model 665RK Kit**

Description	Order No.
665RK cartridge kit, handle marked "PUSH"	<b>CF1417</b>
665RK cartridge kit, handle marked "HOT"	<b>CF1415</b>
665RK cartridge kit, handle marked "COLD"	<b>CF1416</b>

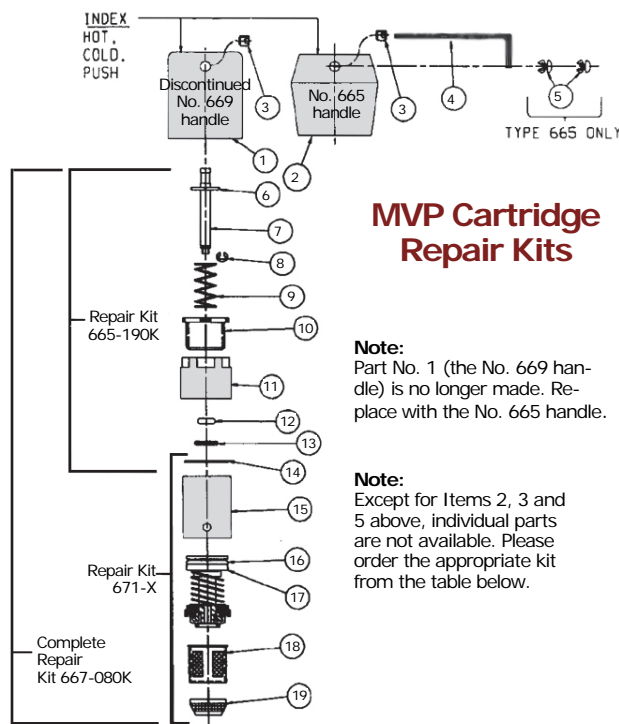

### MVP Cartridge Repair Kits

Part	Repair Kit Description	Order No.
2	665, cast brass handle & items 3,4,5 — Comes with "Red" and "Blue" inserts to designate "HOT" or "COLD" as installed	<b>CF1427</b>
3	Set screw (1 each), #665-116	<b>CF1267</b>
5	Pair of Hot and Cold buttons, #665-309K	<b>CF1432</b>
Kit	665-190K, Assembled Actuator, items 6 to 14	<b>CF1430</b>
Kit	671X, Metering valve cartridge (items 14-19)	<b>CF1435</b>
Kit	667-080K, one each of kits 671X & 665-190K	<b>CF1440</b>

# Chicago Faucet Spouts

## Replacement Gooseneck Spouts

These gooseneck spouts are made of a heavy 11/16" O.D. chrome plated brass tubing. Includes inlet union nut for quick change-out. Shown with standard E3 soft-flow aerators. However, the spouts will take a variety of aerators or outlets as shown below. Be careful to choose the correct "spout end" style:

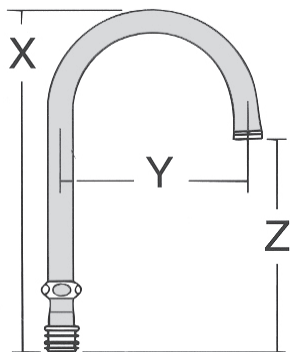

- The **Type "A" spouts** accept aerators with 13/16"-24 female thread connection.
- The **Type "B" spouts** accept aerators with a 3/8" male pipe size connection.
- These gooseneck spouts are field adaptable to be rigid (non-movable) or swing except where noted.
- Order spouts below. Dimensions shown in inches.

Spout Model No.	Accepts Aerator Connection	X	Y	Z	Order No.
<b>Spout "A" Models (*Swing Spout only)</b>					
GN1AE3	13/16"-24 female	8-1/4	3-1/2	5-7/8	<b>CF1355</b>
GN2AE3	13/16"-24 female	9-3/4	5-3/8	6-1/8	<b>CF1360</b>
GN8AE3	13/16"-24 female	11-1/4	8	6-1/8	<b>CF1380</b>
*GN10A	13/16"-24 female	12-7/8	10	5-7/8	<b>CF1382</b>
*GN12A	13/16"-24 female	13-7/8	12	5-7/8	<b>CF1382A</b>
GN2AH8E3	13/16"-24 female	8	5-3/8	4-3/8	<b>CF1370</b>
GN2AH13E3	13/16"-24 female	13	5-3/8	9-1/2	<b>CF1365</b>
GN2AH17E3	13/16"-24 female	17	5-3/8	13-3/8	<b>CF1371</b>
<b>Spout "B" Models (*Swing Spout only)</b>					
GN1BE3	3/8" male IPS	8-1/4	3-1/2	5-3/8	<b>CF1357</b>
GN2BE3	3/8" male IPS	9-3/4	5-3/8	5-5/8	<b>CF1372</b>
GN8BE3	3/8" male IPS	11-1/4	8	5-5/8	<b>CF1381A</b>
*GN10B	3/8" male IPS	12-7/8	10	6-7/8	<b>CF1381M</b>
*GN12B	3/8" male IPS	13-7/8	12	6-7/8	<b>CF1382B</b>
GN2BH8E3	3/8" male IPS	8	5-3/8	4-1/4	<b>CF1373A</b>
GN2BH13E3	3/8" male IPS	13	5-3/8	9	<b>CF1373B</b>
GN2BH17E3	3/8" male IPS	17	5-3/8	12-7/8	<b>CF1373C</b>

## Vacuum Breaker Spouts *Continued . . .*

All the vacuum breaker spouts shown are polished chrome plated and accept a 3/8" male outlet. The vacuum breakers can easily be repaired with the CF1320 vacuum breaker repair kit.

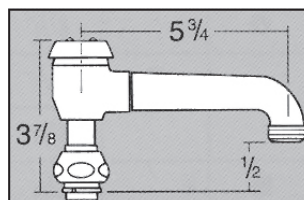

Description	Order No.
L5VB, Cast brass polished chrome	<b>CF1390</b>

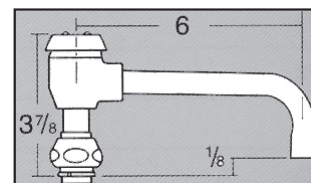

Description	Order No.
L6BVB, polished chrome plated	<b>CF1391</b>

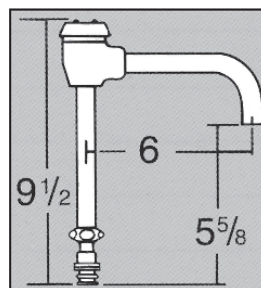

Description	Order No.
GN2BVB, Swing or Rigid setting	<b>CF1373</b>

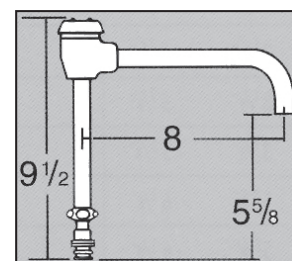

Description	Order No.
GN8BVB, Swing or Rigid setting	<b>CF1381</b>

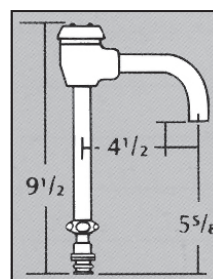

Description	Order No.
GN1BVB, Swing and rigid settings	<b>CF1356</b>

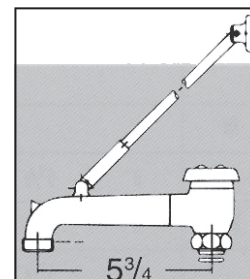

Description	Order No.
897S, 3/4" hose end, pail hook	<b>CF1320B</b>

## Vacuum Breaker Spouts

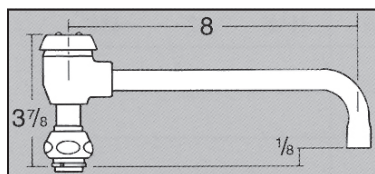

Description	Order No.
L8BVB, Swing and rigid settings	<b>CF1406</b>

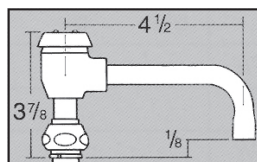

Description	Order No.
S4BVB, polished chrome	<b>CF1394</b>

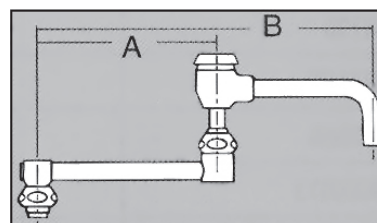

Description	Order No.
DJ13B-VB, double-jointed swing spout "A" = 7" "B" = 13"	<b>CF1326</b>

Description	Order No.
DJ18B-VB double-jointed swing spout "A" = 11 3/4" "B" = 17 3/4"	<b>CF1329</b>

# Chicago Faucet Spouts

## Standard Swing Spouts

These spouts go on any Chicago Faucet that has a removable spout. The E3, 2 gpm aerator with female connection; The E2 outlet has a 3/4" male hose thread connection; The E12 aerator with 13/16" - 27 male thread "Soft-Flo" aerator, 2 gpm flow.

Description	Order No.
HA8, High rise, double bend, E12 aerator	<b>CF1383D</b>

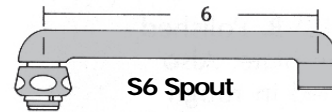
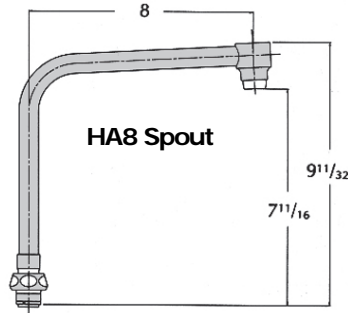

Description	Order No.
S6, standard 6" swing spout, E3 aerator	<b>CF1395</b>

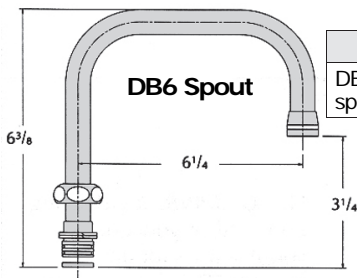

Description	Order No.
DB6, Double bend spout, plain end	<b>CF1333C</b>

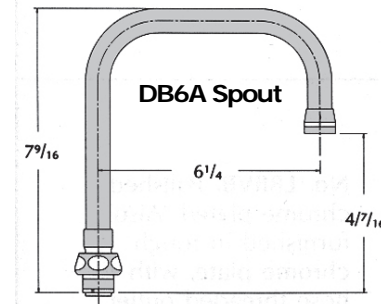

Description	Order No.
DB6A, Double bend spout, "A" spout end	<b>CF1333D</b>

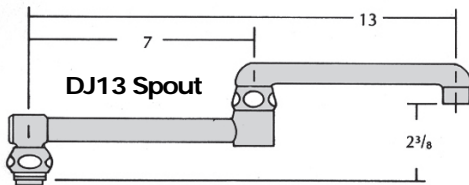

Description	Order No.
DJ13, double jointed 13" spout, E3 aerator	<b>CF1325</b>

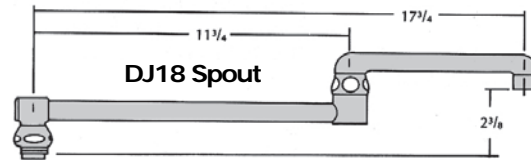

Description	Order No.
DJ18, double jointed 18" spout, E3 aerator	<b>CF1330</b>

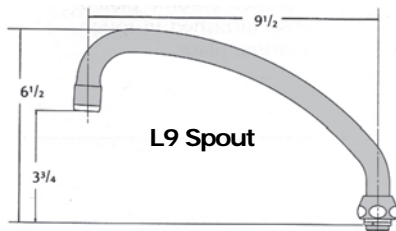

Description	Order No.
L9, standard 9" swing spout, E3 aerator	<b>CF1410</b>

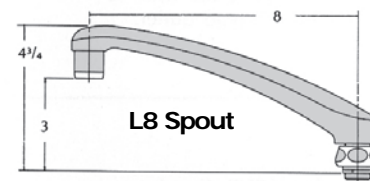

Description	Order No.
L7, standard 7" swing spout, E3 aerator	<b>CF1400</b>
L8, standard 8" swing spout, E3 aerator	<b>CF1405</b>

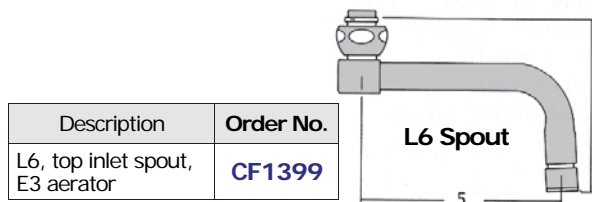

Description	Order No.
L6, top inlet spout, E3 aerator	<b>CF1399</b>

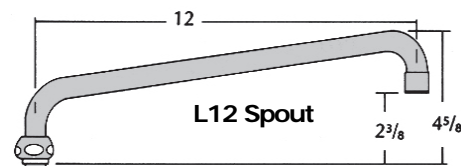

Description	Order No.
L12, 12" swing spout with E3 aerator	<b>CF1412</b>

Description	Order No.
L15, 14" long swing spout with E3 aerator. Picture not shown.	<b>CF1413</b>

# Chicago Faucet Aerators and Handles

## Replacement Aerators and More!

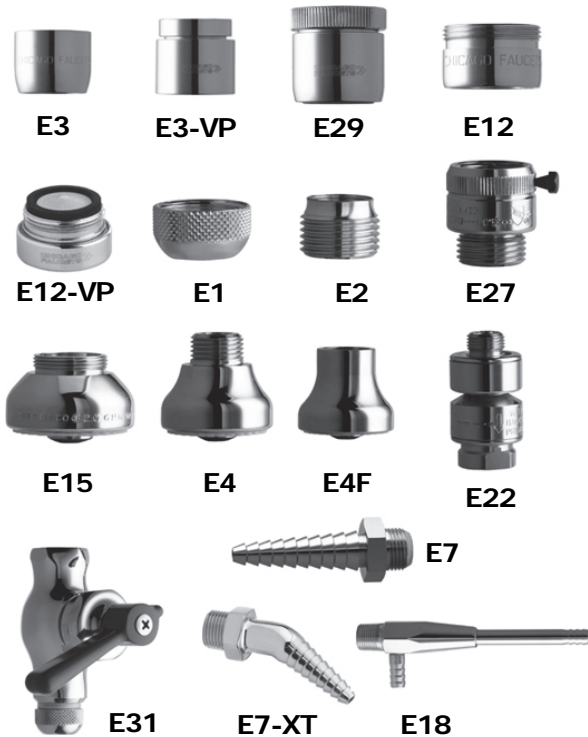

Model No.	Description	Connection	Order No.
E1	Single screen outlet aerator	Fits "A" Spouts	<a href="#">CF1334</a>
E2	3/4" male hose thread outlet	Fits "A" Spouts	<a href="#">CF1335</a>
E3	Standard "Soft-Flo" 2 gpm aerator — <i>The Popular One!</i>	Fits "A" Spouts	<a href="#">CF1340</a>
E3VP	Vandal-Resistant "Soft-Flo" aerator	Fits "A" Spouts	<a href="#">CF1341</a>
E4F	1-3/8" rose spray	3/8" IPS female	<a href="#">CF1345</a>
E22	3/4" male hose thread outlet	Fits "B" Spouts	<a href="#">CF1336</a>
E4	1-3/8" rose spray for "B" spouts	Fits "B" Spouts	<a href="#">CF1344</a>
E7	Lab hose nozzle, 3/8" NPSM male inlet	Fits "B" Spouts	<a href="#">CF1350</a>
E7XT	Lab hose nozzle, 3/8" tapered male inlet	Fits "B" Spouts	<a href="#">CF1350B</a>
E12	"Soft-Flo" 2 gpm aerator	13/16" - 27	<a href="#">CF1352</a>
E15	Spray outlet for lavatory faucets	13/16" - 27	<a href="#">CF1352D</a>
E29	Lam-A-Flow laminar 2 gpm flow outlet	Fits "A" Spouts	<a href="#">CF1353</a>
E18	Aspirator pump, 3/8" male	Fits "B" Spouts	<a href="#">CF1352G</a>
E27	In-line vacuum breaker	3/4" hose	<a href="#">CF1352E</a>

## Replacement Faucet Handles

The new style Chicago Faucet manually operated lavatory faucets use the new 390 lever handles — Very similar to the 369 handles, but the lever has a subtle curve that gives the faucet a more modern look.

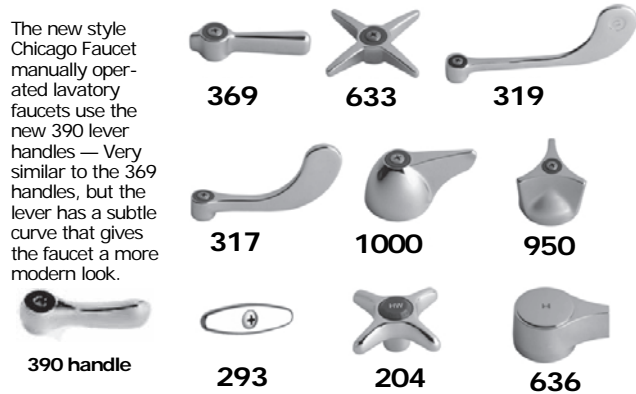

Handle No.	Description	Diameter or Length	Order No.
204	4-arm chrome handle, set of hot & cold	2-1/2"	<a href="#">CF1084D</a>
293	Loose key metal tee handle, no index, one handle	2-1/2"	<a href="#">CF1131</a>
317	Handicapped chrome wrist blade handle, set hot/cold	4"	<a href="#">CE1055</a>
319	Handicapped chrome wrist blade handle, set hot/cold	6"	<a href="#">CE1060</a>
369	2-1/2" chrome lever handle, set of hot & cold	2-1/2"	<a href="#">CE1100</a>
390	Similar to 369 above, but handle is slightly curved.	2-1/2"	<a href="#">CE1119</a>
633	4-arm metal handle, hot & cold	3"	<a href="#">CE1155</a>
636	Single wing chrome brass handle, set of hot & cold	3-1/4"	<a href="#">CE1156B</a>
950	3-wing metal handle, set of hot & cold	2-1/2"	<a href="#">CF1079Y</a>
1000	Single wing metal handle, set of hot & cold	2-7/8"	<a href="#">CF1080</a>



- Same-Day Shipping
- Discount Pricing
- Product Specialists
- [info@StateSupply.com](mailto:info@StateSupply.com)
- Fax: 651.774.7156

**800.772.2099**