

ENGINEERING
TOMORROW



Quick Select Guide—2017

Products and technologies for all your
application needs, today and **tomorrow**

REFRIGERATION & AIR CONDITIONING COMPONENTS

Easy

Find the right
products fast with
our Quick Select
Guide

choose.danfoss.com

Table of Contents

01 - Thermostatic Expansion Valves	4
T2 / TE2 - Thermostatic Expansion Valves and Kits	4
TUA/TUAE - Thermostatic Expansion Valves and Kits	7
TUA - Thermostatic Expansion Valves for Ice Machines	10
TR6 - Thermostatic Expansion Valves and Kits	12
TGE - Thermostatic Expansion Valves	14
02 - Thermostats and Pressure Switches	16
Universal Service Thermostats	16
KPU - Pressure Switches	18
KPU - Temperature Controls	20
MP - Differential Pressure / Lube Oil Protection Switches	22
03 - Solenoid Valves	24
EVR - Solenoid Valves	24
04 - Pressure Controlled Water Valves	26
WVFX - Pressure Controlled Water Valves	26
05 - Pressure Regulators	28
KVP - Evaporating Pressure Regulators	28
KVL - Crankcase Pressure Regulators	28
KVR - Condensing Pressure Regulator	28
NRD - Differential Pressure Regulators	28
KVC - Hot Gas Bypass Pressure Regulators	28
CPCE - Hot Gas Bypass Pressure Regulators	28
06 - Filter Driers	30
DCL - Liquid Line Filter Driers	30
DCB - Bi-flow Filter Driers	30
DAS - Suction Line Filter Driers	30
DCR - Filter Drier Cores	30
DCL with Schrader Valve - Filter Driers	32

07 - Ball Valves	33
GBC - Ball Valves	33
08 - Sight Glasses	34
SGP - Sight Glasses	34
09 - Light Commercial Compressors	35
Light Commercial Compressors	35
10 - Condensing Units	38
Optyma™ - Condensing Units	38
Optyma™ Slim - Outdoor Condensing Units	42
11 - Reciprocating Compressors	46
MT / MTZ - Medium/High Temperature Reciprocating Compressors	46
NTZ - Low Temperature Reciprocating Compressors	48
12 - Scroll Compressors	49
H Series - Residential and Light Commercial Scroll Compressors	49
S Series - Light Commercial and Commercial Scroll Compressors	52
12 - Capacitors and Relays	55
13 - Spare Parts and Accessories	56

T2 / TE2 - Thermostatic Expansion Valves

Danfoss T2/TE2 brass body thermostatic expansion valves feature flare inlet and outlet connections. By pairing one valve body with one of eight replaceable orifices, a contractor can satisfy applications from -40°F to $+50^{\circ}\text{F}$ and from $\frac{1}{8}$ to $5\frac{3}{4}$ tons capacity (see capacity chart for specifics).

Features T2 / TE2

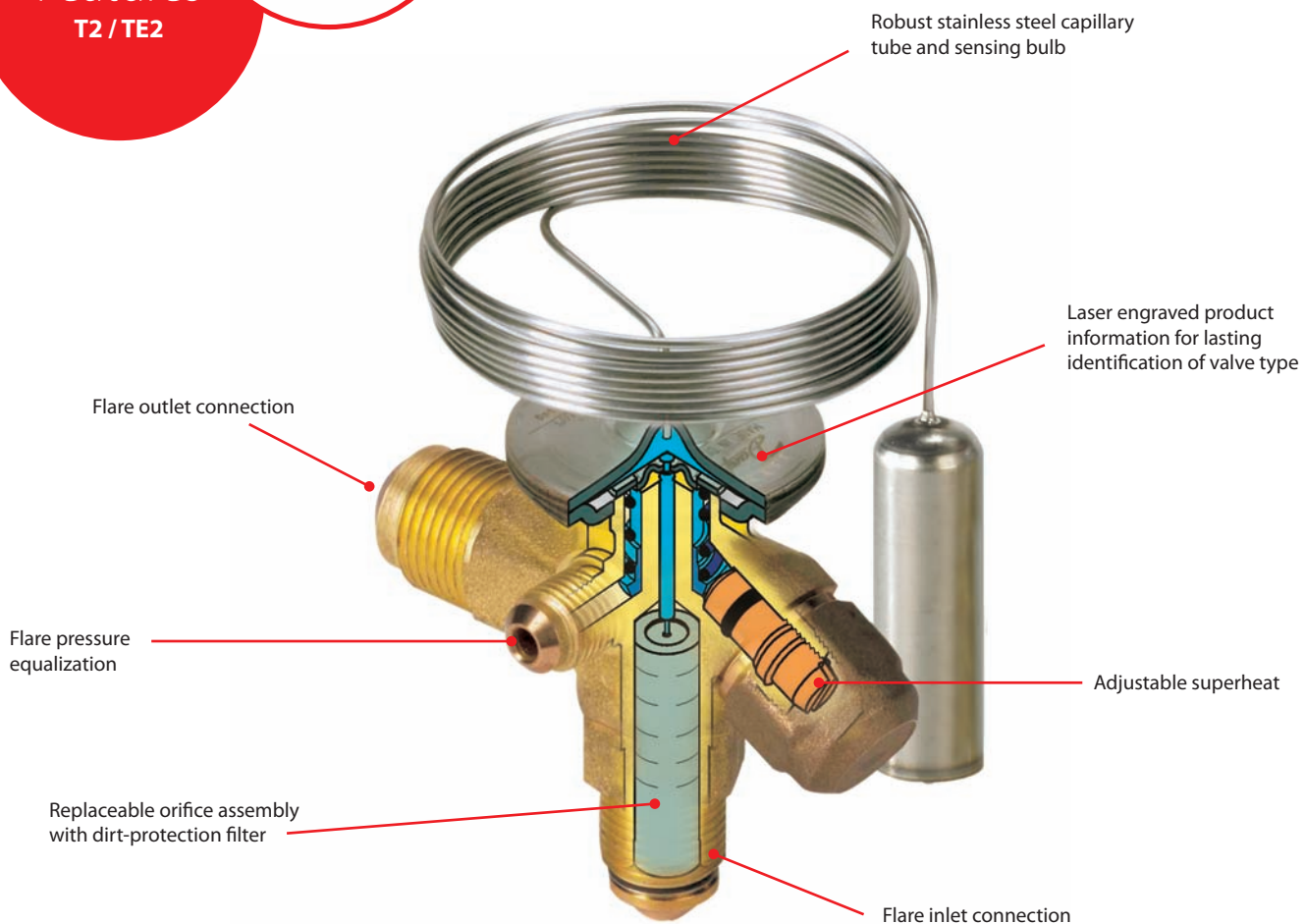

Facts

Applications:

- Traditional refrigeration
- Self-contained refrigerators
- Transport refrigeration
- Supermarket refrigeration
- Temperature range: -40°F to $+50^{\circ}\text{F}$
- Capacity range: $\frac{1}{8}$ to $5\frac{3}{4}$ tons (varies by refrigerant)
- Refrigerants: R-22, R-407C, R-134a, R-404A
- Functional valve consists of valve body and orifice
- Flare/solder adaptor available

Selection and Installation Instructions

1. Select Valve Body

Select the valve body based on refrigerant and need for internal or external equalization using the table on the next page under "Select Valve Body."

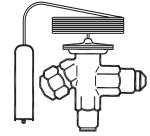

2. Select Orifice

T2/TE2 valve capacities are based on the installed orifice. To select the correct size orifice, use one of the two methods using the "Select Orifice" section on the following page.



3. Assemble Valve and Install into System

- Slide the orifice into the valve body and secure using liquid line flare nut
- Attach evaporator inlet or distributor assembly to valve outlet flare nut
- Tighten both flare nuts
 - Specification for inlet is 26–33 ft.-lbs
 - Specification for outlet is 37–52 ft.-lbs
- Secure sensing bulb with enclosed bulb strap to suction line. Bulb should be located between 1:00 and 4:00 on the tube, and the strap should be tight enough that no bulb movement is possible.
- Wrap included insulation tape beginning one inch before the bulb and overlapping each wrap, finishing one inch beyond the bulb on the other end.

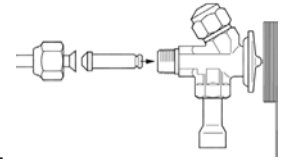

4. Adjust Superheat

- Remove the cap
- Make superheat adjustments $\frac{1}{4}$ turn at a time ($\frac{1}{4}$ turn ≈ 1.75 °F).
 - Turning clockwise increases superheat.
 - Turning counter-clockwise decreases superheat.
- Reinstall the cap



Easy to carry kits for truck stock

All T2/TE2 valve bodies and orifice featured on the next page and a hex key for superheat adjustment.

068Z7100

Both TUA/TUAE valve bodies and orifices and T2/TE2 and orifices plus gaskets for TUA/TUAE and a hex key for superheat adjustment.

068U7001

Kits are plastic cases with foam inserts, all valves and orifices, and instructions for selection and installation of the valves. Empty kits and foam available upon request.

Product Selection

1. Select Valve Body

Equalization	R-22	R-407C	R-404A	R-134a
Internal	068Z3206		068Z3400	068Z3346
External	068Z3209		068Z3403	068Z3348

All valves above have 3/8 in. x 1/2 in. flare connections and are designed for evaporator temperatures -40 °F to +50 °F (N charge). Other variations available, please contact your local Danfoss authorized wholesaler.

2. Select Orifice

T2/TE2 valve capacities are based on the installed orifice.
To select the correct size, use one of the two methods below:

A. System characteristics: Select the orifice using appropriate refrigerant, evaporator temperature, and system capacity.

OR

B. Nominal capacity of the installed valve: Use the nominal capacity of the originally installed valve and match with the nominal capacity in chart (3rd column from left).

Technical data and ordering

T2 and TE2 (IF EXACT CAPACITY CANNOT BE FOUND, USE NEXT LARGER ORIFICE)

R-22		R-407C	Evaporator temperature (°F)									
Orifice size	Danfoss Code No.	Nominal capacity of installed valve ¹ (tons)	-40	-30	-20	-10	0	10	20	30	40	50
			Rated capacity ² (tons)									
0X	068-2002	1/4	1/5	1/4	1/4	1/4	1/4	1/4	1/4	1/4	1/4	1/4
00	068-2003	1/2	1/4	1/3	1/3	1/3	1/3	1/3	1/2	1/2	1/2	1/2
01	068-2010	1	1/3	1/3	1/2	1/2	3/4	3/4	3/4	1	1	1
02	068-2015	1 1/2	1/3	1/2	1/2	3/4	3/4	1	1	1 1/4	1 1/2	1 1/2
03	068-2006	2 1/2	3/4	3/4	1	1	1 1/2	1 1/2	1 3/4	2	2 1/4	2 1/2
04	068-2007	3 1/2	1	1	1 1/2	1 3/4	2	2 1/2	2 3/4	3	3 1/2	3 1/2
05	068-2008	5	1 1/2	1 3/4	2	2 1/2	2 3/4	3	3 3/4	4 1/4	4 3/4	5
06	068-2009	5 1/2	1 1/2	2	2 1/2	2 3/4	3	3 3/4	4 1/2	5	5 1/2	5 3/4

R-404A		Evaporator temperature (°F)										
Orifice size	Danfoss Code No.	Nominal capacity of installed valve ¹ (tons)	-40	-30	-20	-10	0	10	20	30	40	50
			Rated capacity ² (tons)									
0X	068-2002	1/6	1/8	1/6	1/6	1/6	1/6	1/5	1/5	1/5	1/5	1/6
00	068-2003	1/3	1/5	1/5	1/4	1/4	1/3	1/3	1/3	1/3	1/3	1/3
01	068-2010	3/4	1/4	1/3	1/3	1/3	1/2	1/2	1/2	3/4	3/4	3/4
02	068-2015	1	1/4	1/3	1/3	1/2	1/2	3/4	3/4	1	1	1
03	068-2006	1 3/4	1/2	1/2	3/4	3/4	1	1 1/2	1 1/2	1 3/4	1 3/4	1 3/4
04	068-2007	2 3/4	3/4	3/4	1	1 1/2	1 1/2	2	2 1/2	2 1/2	3	3
05	068-2008	3 3/4	1	1	1 1/2	1 3/4	2	2 1/2	3	3 1/2	3 3/4	4
06	068-2009	4 1/2	1	1 1/2	1 3/4	2	2 1/2	3	3 3/4	4	4 1/2	4 1/2

R-134a		Evaporator temperature (°F)										
Orifice size	Danfoss Code No.	Nominal capacity of installed valve ¹ (tons)	-40	-30	-20	-10	0	10	20	30	40	50
			Rated capacity ² (tons)									
0X	068-2002	1/5	1/8	1/6	1/6	1/6	1/5	1/5	1/5	1/5	1/5	1/5
00	068-2003	1/3	1/6	1/5	1/5	1/4	1/4	1/4	1/3	1/3	1/3	1/3
01	068-2010	1/2	1/5	1/4	1/4	1/3	1/3	1/3	1/2	1/2	1/2	1/2
02	068-2015	3/4	1/4	1/4	1/3	1/3	1/2	1/2	1/2	1/2	3/4	3/4
03	068-2006	1 1/2	1/3	1/3	1/2	1/2	3/4	3/4	1	1	1 1/4	1 1/2
04	068-2007	1 3/4	1/2	1/2	3/4	3/4	1	1 1/4	1 1/2	1 1/2	1 3/4	2
05	068-2008	2 1/2	3/4	3/4	1	1	1 1/2	1 1/2	1 3/4	2	2 1/2	2 1/2
06	068-2009	3	3/4	1	1 1/4	1 1/2	1 1/2	2	2 1/4	2 1/2	2 3/4	3

All capacity data is in accordance to ARI 750-2007.

¹ Nominal capacity based on condensing temperature of 100 °F, an evaporator temperature of 40 °F, liquid temperature of 98 °F ahead of the valve.

² Capacity based on condensing temperature of 95 °F and a vapor free liquid temperature of 88 °F ahead of the expansion valve.

Spare parts and accessories are available on pages 56.

TUA / TUAE - Thermostatic Expansion Valves

Danfoss TUA/TUAE stainless steel thermostatic expansion valves feature solder inlet and outlet connections. By pairing one valve body with one of ten replaceable orifices, a contractor can satisfy applications from -40 °F to + 50 °F and up to 4 ½ tons capacity (see capacity chart for specifics).

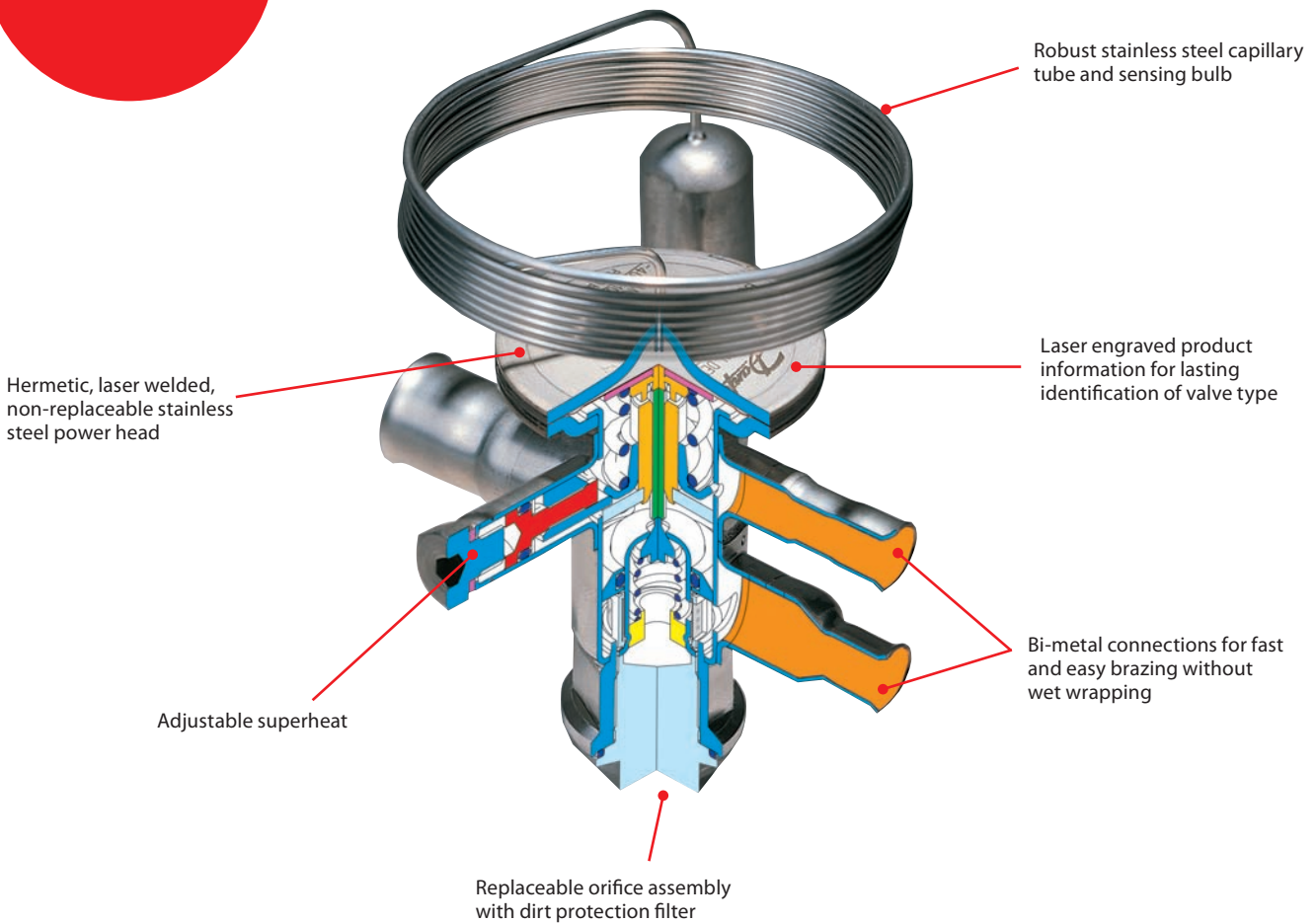
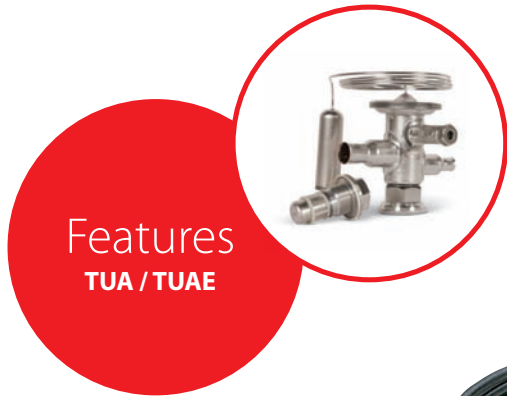

Facts

Applications:

- Traditional refrigeration
- Self-contained refrigerators
- Transport refrigeration
- Supermarket refrigeration
- Temperature range: -40 °F to +50 °F
- Capacity range: 1/80 to 4 ½ tons (varies by refrigerant)
- Refrigerants: R-22, R-407C, R-134a, R-404A
- Functional valve consists of valve body and orifice

Scan the QR Code for a video with more information on the TUA valve features and installation or visit <http://bit.ly/TUAINSTALL>



Selection and Installation Instructions

1. Select Valve Body

Select the valve body based on refrigerant and need for internal or external equalization using the table on the next page under "Select Valve Body."

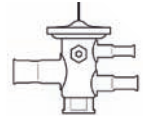

2. Select Orifice

1. Select one of ten orifices using the "Select Orifice" section on the following page.
2. Prior to installing into system, verify that only mesh portions of the screen cover the orifice inlet.



3. Assemble Valve

1. Place one drop of refrigerant oil between the screen cage and the pushpin.
 2. Verify that the metal gasket is seated on the base of the orifice.
 3. Tighten orifice into valve (specification is 26–30 ft.-lbs.). In addition to eliminating leaks, proper torquing insures proper superheat control.
- ▶ Replace the metal washer/gasket that is mounted at the base of the orifice every time you change the orifice assembly or remove it from the valve body.

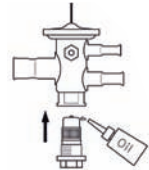

4. Braze Valve into System

1. Clean and insert copper tubing into appropriate connection on valve.
 2. Direct torch at copper tubing until it begins to color (10–15 seconds).
 3. Briefly direct torch on valve connection (2–5 seconds).
 4. Apply brazing alloy until it flows.
Do not try to fill the ridge. Attempts to do so may clog the connector.
- ▶ Sweat connections using any common brazing alloy (minimum 5% silver, recommended 15% silver). As internal connector surface is copper, connections are copper to copper, and there is no need for use of high content silver solder or flux.
- ▶ **NO WET WRAP REQUIRED**
5. Secure sensing bulb with enclosed bulb strap to suction line. Bulb should be located between 1:00 and 4:00 on the tube, and the strap should be tight enough that no bulb movement is possible.
 6. Wrap included insulation tape beginning one inch before the bulb and overlapping each wrap, finishing one inch beyond the bulb on the other end.

5. Adjust Superheat

1. Remove the cap with a $\frac{5}{32}$ inch hex key.
 2. Make superheat adjustments $\frac{1}{4}$ turn at a time ($\frac{1}{4}$ turn $\approx 1^\circ\text{F}$).
 - Turning clockwise increases superheat.
 - Turning counter-clockwise decreases superheat.
 3. Reinstall the cap.
- ▶ Expansion valves on low temperature systems may require more adjustment as the factory setting is for medium temperature systems.



Easy to carry kits for truck stock

All TUA/TUAE valve bodies and orifice featured on the next page and a hex key for superheat adjustment.

068U7000

Both TUA/TUAE valve bodies and orifices and T2/TE2 and orifices plus gaskets for TUA/TUAE and a hex key for superheat adjustment.

068U7001

Kits are plastic cases with foam inserts, all valves and orifices, and instructions for selection and installation of the valves. Empty kits and foam available upon request.

Product Selection

1. Select Valve Body

Equalization	R-22	R-407C	R-404A	R-134a
Internal	068U2235		068U2285	068U2205
External	068U2237		068U2287	068U2207

All valves above have 3/8 in. x 1/2 in. solder ODF connections and are designed for evaporator temperatures -40 °F to +50 °F (N charge). Other variations available, please contact your local Danfoss authorized wholesaler.

2. Select Orifice

TUA/TUAE valve capacities are based on the installed orifice.
To select the correct size, use one of the two methods below:

A. System characteristics: Select the orifice using appropriate refrigerant, evaporator temperature, and system capacity.

OR

B. Nominal capacity of the installed valve: Use the nominal capacity of the originally installed valve and match with the nominal capacity in chart (3rd column from left).

Technical data and ordering

TUA and TUAE (IF EXACT CAPACITY CANNOT BE FOUND, USE NEXT LARGER ORIFICE)

R-22		R-407C	Evaporator temperature (°F)										
Orifice size	Danfoss Code No.	Nominal capacity of installed valve ¹ (tons)	-40	-30	-20	-10	0	10	20	30	40	50	
			Rated capacity ² (tons)										
0	068U1030	1/8	1/15	1/15	1/15	1/10	1/8	1/8	1/6	1/6	1/6	1/5	
1	068U1031	1/5	1/10	1/8	1/8	1/6	1/6	1/5	1/5	1/5	1/4	1/4	
2	068U1032	1/4	1/10	1/8	1/8	1/6	1/5	1/4	1/4	1/4	1/3	1/3	
3	068U1033	1/3	1/8	1/6	1/5	1/4	1/4	1/3	1/3	1/3	1/3	1/3	
4	068U1034	1/2	1/4	1/4	1/4	1/3	1/3	1/2	1/2	1/2	3/4	3/4	
5	068U1035	3/4	1/3	1/3	1/3	1/2	1/2	3/4	3/4	3/4	1	1	
6	068U1036	1 1/2	1/2	1/2	1/2	3/4	3/4	1	1 1/4	1 1/2	1 1/2	1 1/2	
7	068U1037	2	1/2	3/4	3/4	1	1	1 1/3	1 1/2	1 3/4	2	2	
8	068U1038	2 3/4	1	1	1 1/3	1 1/2	1 3/4	2	2 1/2	2 1/2	3	3	
9	068U1039	4	1 1/3	1 1/2	1 3/4	2	2 1/2	2 3/4	3 1/4	3 1/2	4	4 1/2	
R-404A			Evaporator temperature (°F)										
Orifice size	Danfoss Code No.	Nominal capacity of installed valve ¹ (tons)	-40	-30	-20	-10	0	10	20	30	40	50	
			Rated capacity ² (tons)										
0	068U1030	1/8	1/20	1/20	1/15	1/15	1/10	1/8	1/8	1/6	1/6	1/6	
1	068U1031	1/5	1/15	1/15	1/10	1/8	1/8	1/6	1/6	1/5	1/5	1/5	
2	068U1032	1/4	1/15	1/15	1/10	1/8	1/6	1/5	1/5	1/4	1/4	1/4	
3	068U1033	1/3	1/10	1/8	1/8	1/6	1/5	1/4	1/4	1/3	1/3	1/3	
4	068U1034	1/2	1/6	1/5	1/4	1/4	1/3	1/3	1/2	1/2	1/2	1/2	
5	068U1035	3/4	1/5	1/4	1/3	1/3	1/2	1/2	1/2	3/4	3/4	3/4	
6	068U1036	1 1/4	1/3	1/3	1/2	1/2	3/4	3/4	1	1	1	1 1/3	
7	068U1037	1 1/2	1/3	1/2	1/2	3/4	1	1	1 1/3	1 1/2	1 1/2	1 3/4	
8	068U1038	2 1/3	1/2	3/4	1	1	1 1/3	1 1/2	2	2	2 1/3	2 1/2	
9	068U1039	3 1/3	3/4	1	1 1/3	1 1/2	2	2 1/4	2 1/2	3	3 1/2	3 3/4	
R-134a			Evaporator temperature (°F)										
Orifice size	Danfoss Code No.	Nominal capacity of installed valve ¹ (tons)	-40	-30	-20	-10	0	10	20	30	40	50	
			Rated capacity ² (tons)										
0	068U1030	1/8	1/30	1/20	1/20	1/20	1/15	1/15	1/10	1/10	1/6	1/6	
1	068U1031	1/6	1/20	1/15	1/15	1/10	1/10	1/8	1/8	1/6	1/6	1/5	
2	068U1032	1/5	1/15	1/15	1/15	1/10	1/8	1/6	1/6	1/5	1/5	1/5	
3	068U1033	1/4	1/15	1/10	1/8	1/8	1/6	1/5	1/5	1/4	1/4	1/4	
4	068U1034	1/3	1/6	1/6	1/5	1/5	1/4	1/4	1/3	1/3	1/3	1/2	
5	068U1035	1/2	1/5	1/5	1/4	1/4	1/3	1/3	1/2	1/2	1/2	1/2	
6	068U1036	3/4	1/4	1/4	1/3	1/3	1/2	1/2	3/4	3/4	1	1	
7	068U1037	1 1/4	1/3	1/3	1/2	1/2	3/4	3/4	1	1	1 1/4	1 1/2	
8	068U1038	1 3/4	1/2	1/2	3/4	3/4	1	1 1/4	1 1/2	1 3/4	2	2	
9	068U1039	2 1/2	3/4	1	1	1 1/3	1 1/2	1 3/4	2	2 1/3	2 3/4	3	

All capacity data is in accordance to ARI 750-2007.

¹ Nominal capacity based on condensing temperature of 100 °F, a vapor free liquid temperature of 98 °F ahead of the expansion valve and an evaporator temperature of 40 °F.

² Capacity based on condensing temperature of 95 °F and a vapor free liquid temperature of 85 °F ahead of the expansion valve. Spare parts and accessories are available on pages 56.

TUA - Thermostatic Expansion Valves for Ice Machines

These kits are designed with contractors in mind to help save time and money by providing a universal valve that can easily be adapted to replace most OEM specific TXVs. Two kits are available, each with a

valve body and a selection of three orifice sizes, copper fittings (two elbows and one reducer), a patented bulb strap, and insulation tape.

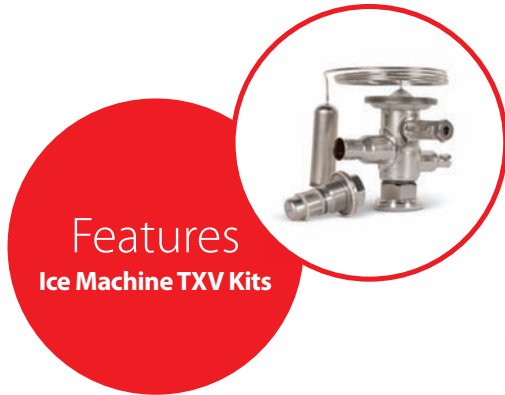

Hermetic, laser welded, non-replaceable stainless steel power head

Robust stainless steel capillary tube and sensing bulb

Laser engraved product information for lasting identification of valve type

Decades of experience working with ice machines ensures optimal bulb charge for fast and precise capacity control

Bi-metal connections for fast and easy brazing without wet wrapping

Replaceable orifice allows for capacity adaptations with a single valve and access to the screen for cleaning

Kit includes 3 copper fittings: 2 elbows and 1 reducer

Facts

Applications:

- Ice machines
- Ice machine capacity: 75 to 2300 pounds per day
- Two kits available
- Each kit contains:
 - Exchangeable orifice thermostatic expansion valve
 - Selection of (3) orifice sizes
 - Copper fittings (2 elbows and 1 reducer)
 - Copper bulb strap
 - Insulation tape
 - Installation guide

Selection and installation instructions

1. Determine the type of machine (cube, flake, or nugget), output of the machine in pounds of ice per 24 hours, and the number of expansion devices installed.
 2. Divide the output in pounds of ice by the number of expansion valves.
 3. Use the appropriate selection table below under Technical data and ordering to determine the correct orifice size for the ice output per expansion valve.
 4. Adhere to start up and performance measurements as specified in the Instructions included with the kit.
- After the new valve is installed and the machine is back in operation, it is important to verify appropriate superheat performance. Cube ice machines typically start cycles with high superheat, which decreases as a harvest cycle approaches.

A properly sized and adjusted valve will assure adequate capacity during all phases of the freeze cycle and positive superheat through the cycle. As the valve nears the end of the freeze cycle it is imperative that you accurately measure the evaporator superheat.

1. Inspect the ice for sufficient production.
2. Inspect the suction line just before the compressor for any frost that could indicate liquid flooding.
3. Measure superheat at the end of the freeze cycle.
4. If superheat is between 10 °F and 18 °F, ice is forming appropriately, and there is no sign of liquid flooding, the installation is complete.
5. If superheat is below 10 °F, increase superheat.
6. If superheat is above 18 °F, decrease superheat.
7. If after adjusting superheat you still see too low superheat or liquid flooding, please install the next smaller orifice and repeat this process.
8. If after adjusting superheat you still see too high superheat or insufficient ice formation, please install the next larger orifice and repeat this process.

If superheat adjustment is necessary, follow these steps:

1. Remove the cap with a 5/32 inch hex key.
2. Make superheat adjustments 1/4 turn at a time (1/4 turn ≈ 1 °F).
 - Turning clockwise increases superheat.
 - Turning counter-clockwise decreases superheat.
3. Reinstall the cap.

Technical data and ordering

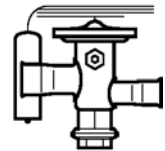

TUA for Ice Machines

Expansion valve kit for small ice machines

Danfoss Code No. 068U4900 ¹		
Cuber	Flaker/Nugget	
Nameplate lbs. of ice/24 hrs per valve		Estimated orifice size
75–150	75–200	1
151–350	201–500	3
351–600	501–950	5

Valve in kit above has straightway 1/4 in. × 3/8 in. ODF connections.

Expansion valve kit for large ice machines

Danfoss Code No. 068U4901 ¹		
Cuber	Flaker/Nugget	
Nameplate lbs. of ice/24 hrs per valve		Estimated orifice size
351–600	501–950	5
601–1200	951–1650	7
1201–1800	1651–2300	8

Valve in kit above has straightway 3/8 in. × 1/2 in. ODF connections.

¹Ice machine kits contain valve, (3) orifices in corresponding tables, (2) elbow fittings, (1) reducer, copper bulb strap, insulation tape and instructions. Spare parts and accessories are available on pages 56.

Scan the QR Code for a video with more information on the TUA ice machine kits or visit <http://bit.ly/TUAicekit>



TR6 - Thermostatic Expansion Valve Kits

Danfoss TR6 kits include a valve, Aeroquip, Chatleff, and 3/8 inch flare fittings for evaporator connections, insulating tape, a bulb strap and instructions for easy installation in the field. All valves have a balanced port design which reduces the influence from varying condensing

pressures. The valves feature a built-in check valve for heat pump applications and an anti-hunt bulb charge, optimized for residential A/C requirements.

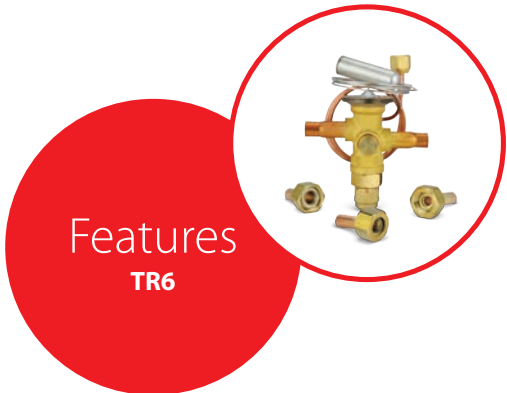

Features
TR6

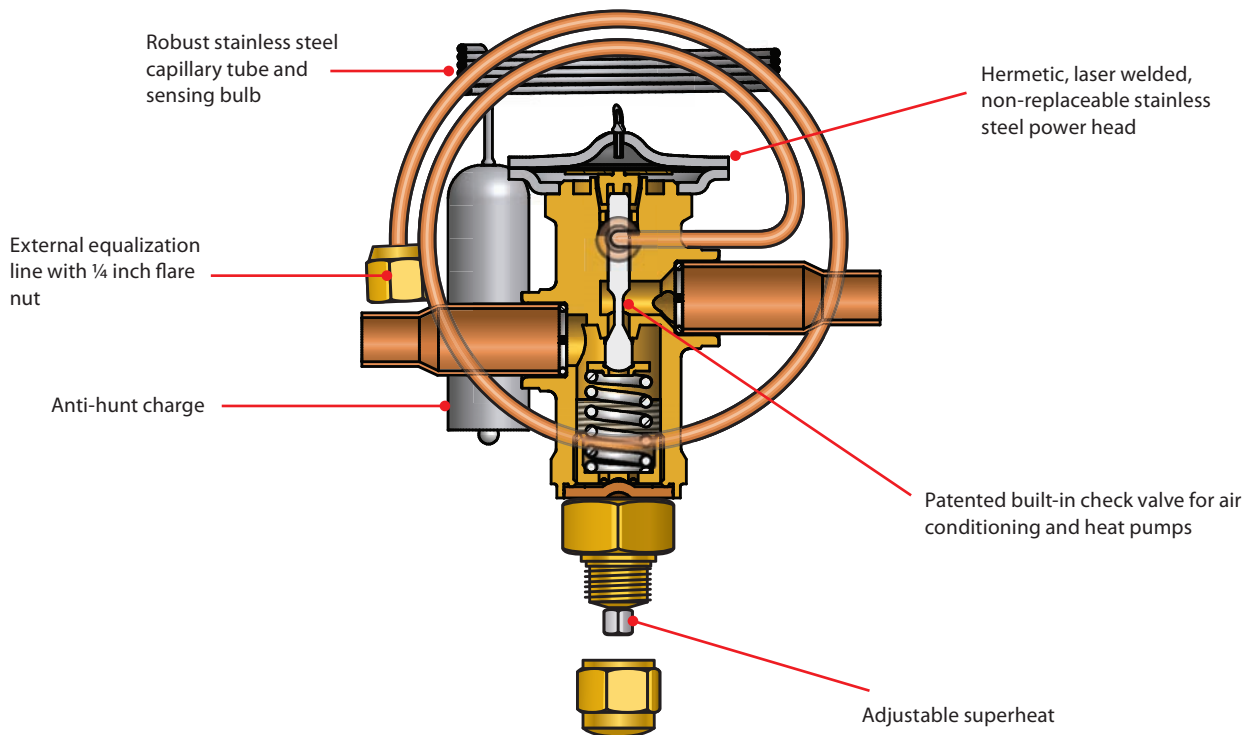

Facts

Applications:

- Residential air conditioning
- Rooftops
- Heat pumps
- Light commercial air conditioning

- Refrigerants: R-22, R-407C, R-410A
- Capacity range: 1 1/2 to 6 Tons
- Temperature range: 14 °F to 59 °F

Kits Include:

- Thermostatic Expansion Valve
- Aeroquip, Chatleff, 3/8 inch flare fittings
- Insulating tape
- Bulb strap
- Installation guide

Technical data and ordering

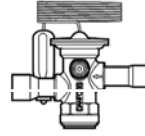

TR6

Refrigerant	System capacity (tons)	Solder ODF connection (in.)	Temperature range (°F)	Danfoss Code No. ¹
R-410A	1 ½-3	¾ × ¾	14 to 59	067L5955
	3 ½-4			067L5956
	4 ½-5			067L5957
R-22 R-407C	1 ½-2			067L5856
	2 ½-3			067L5857
	3 ½-4			067L5858
	5-6	067L5859		

¹The valve kits listed above are standard aftermarket valves and are built with straightway connections, internal check valve, 24 in. equalization line with ¼ in. flare nut, fixed orifice, and adjustable superheat spindle. Spare parts and accessories are available on pages 56.

Easy to carry kits for truck stock

All (3) R-410A TR6 valve kit (pictured below, left)	067L7000
All (4) R-22 TR6 valve kits (pictured below, right)	067L7001



Scan the QR Code for a video with more information on TR6 valve features and installation or visit <http://bit.ly/TR6install>



TGE - Thermostatic Expansion Valves

Danfoss TGE thermostatic expansion valves are designed for commercial air conditioning and refrigeration. They feature a balanced port design which reduces the influence from varying condensing pressures. The air conditioning valves in this catalog

feature an anti-hunt charge optimized for A/C applications and the refrigeration valves are designed for stable operation across a wide temperature range.

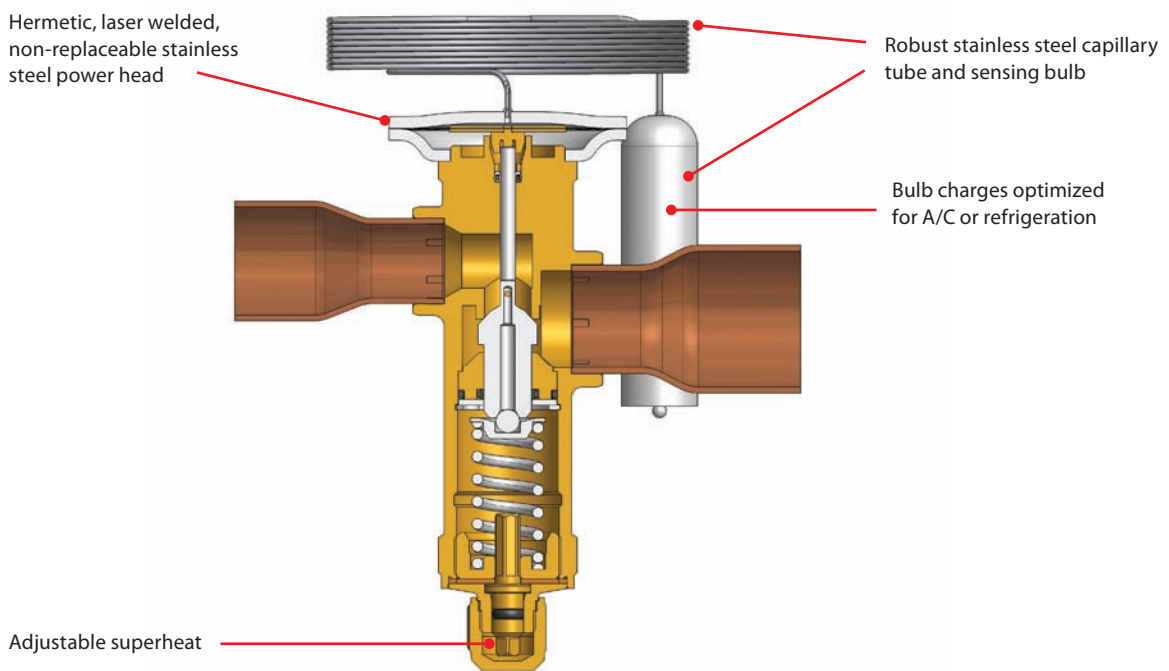

Facts

Applications:

- Traditional refrigeration
- Residential air conditioning
- Rooftops
- Commercial air conditioning
- Chillers

- Refrigerants: R-22, R-407C, R-410A, R-404A, R-507A, R-134a
- Capacity range: 9 to 46 tons (varies by refrigerant)

- Temperature range:
 - Refrigeration Valves: -40 °F to +50 °F
 - Air Conditioning Valves: -22 °F to +60 °F
- Balanced port

Technical data and ordering

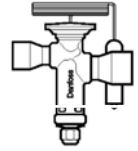

TGE

Danfoss Type	Competitor Model Numbers	Nominal capacity (tons) ³	Solder ODF connection (in.)	Danfoss Code No.	
R-22, MAH charge¹		R-407C, MAH charge¹			
TGEX 10	SVE-5, EVRE-5	HFES-5H	6	½ × ⅝	067N9403
TGEX 10			6	½ × ⅞	067N9404
TGEX 10	SVE-6, EVRE-6		7 ½	⅝ × ⅞	067N9406
TGEX 10			7 ½	⅝ × 1 ½	067N9483
TGEX 10	SVE-8, SVE-10, EBSVE 8, EVRE 8, EVRE 10	HFES-8H, HFES-10H, TRAE-10H	11	⅝ × ⅞	067N9407
TGEX 20	EBSVE 11, EVRE 12		12	⅝ × ⅞	067N9409
TGEX 20	EBSVE15, OVE 15	HFES-15H, TRAE-15H	15	⅝ × 1 ½	067N9411
TGEX 20			15	⅞ × 1 ½	067N9412
TGEX 20			18	⅞ × 1 ½	067N9413
TGEX 40	EBSVE 20, OVE 20	HFES-20H, TRAE 20H	26	⅞ × 1 ¾	067N9415
TGEX 40	OVE 30	TRAE 30H	30	1 ½ × 1 ¾	067N9418
TGEX 40	OVE 40	TRAE 40H	38	1 ½ × 1 ¾	067N9419
R-410A, MAH charge¹					
TGEL 10	ERZE-8		9	⅝ × ⅞	067N9206
TGEL 10	ERZE-12.5	TFES-12Z	13	⅝ × ⅞	067N9207
TGEL 20	ERZE-15	TFES-16Z	15	⅝ × ⅞	067N9209
TGEL 20			15	⅝ × 1 ½	067N9210
TGEL 20	OZE-20		23	⅞ × 1 ½	067N9213
TGEL 20			23	1 ½ × 1 ½	067N9284
TGEL 40	OZE-25		31	⅞ × 1 ½	067N9285
TGEL 40			31	⅞ × 1 ¾	067N9215
TGEL 40	OZE-35		35	1 ½ × 1 ¾	067N9218
TGEL 40			46	1 ½ × 1 ¾	067N9219
R-134a, N charge²					
TGEN 10	SJE-5, SJE-6, EBSJE-5	HFES-6M	7	⅝ × 1 ½	067N5158
TGEN 20	EBSJE-7	HFES-7.5M	8	⅝ × ⅞	067N5159
TGEN 20	EBSJE-12, OJE-12	HFES-11M	12	⅞ × 1 ½	067N5163
TGEN 40	OJE-16	HFES-14M, TRAE-13M, TRAE-14M	17	1 ½ × 1 ½	067N5254
TGEN 40			20	1 ½ × 1 ½	067N5255
TGEN 40	OJE-23	TRAE-22M	25	1 ½ × 1 ¾	067N5169
R-404A, N charge²		R-507A, N charge²			
TGES 10	SSE-3	HFES-3.5S	4	½ × ⅞	067N6151
TGES 10	SSE-4	HFES-5S	5	½ × ⅞	067N6166
TGES 10			5	⅝ × ⅞	067N6150
TGES 10	SSE-6, SSE-7, EBSSE-6	HFES-7S	7 ½	⅝ × ⅞	067N6154
TGES 20	EBSSE-7.5	TRAE-8S	9	⅝ × ⅞	067N6158
TGES 20	EBSSE-10, OSE-9	HFES-10S	11	⅝ × ⅞	067N6188
TGES 20			11	⅝ × 1 ½	067N6155
TGES 20			11	⅞ × 1 ½	067N6181
TGES 20	EBSSE-13, OSE-12	HFES-13S, TRAE-12S	13	⅞ × 1 ½	067N6162
TGES 20	OSE-21	TRAE-20S	21	1 ½ × 1 ¾	067N6186

¹MAH charge: -22 °F to +60 °F, Maximum operating temperature = 300 °F

²N charge: -40 °F to +50 °F, Maximum operating temperature = 210 °F

³Nominal capacity based on ARI standard: Evaporating temperature = 40 °F, Liquid temperature = 98 °F, Condensing temperature = 100 °F

Spare parts and accessories are available on pages 56.

Universal Service Thermostat

Danfoss universal service thermostats are kitted with all the necessary accessories for standard applications, ensuring a quick and easy installation. Thanks to the integrated enclosed brake device, these controls can be safely used in isobutene or propane refrigeration systems.

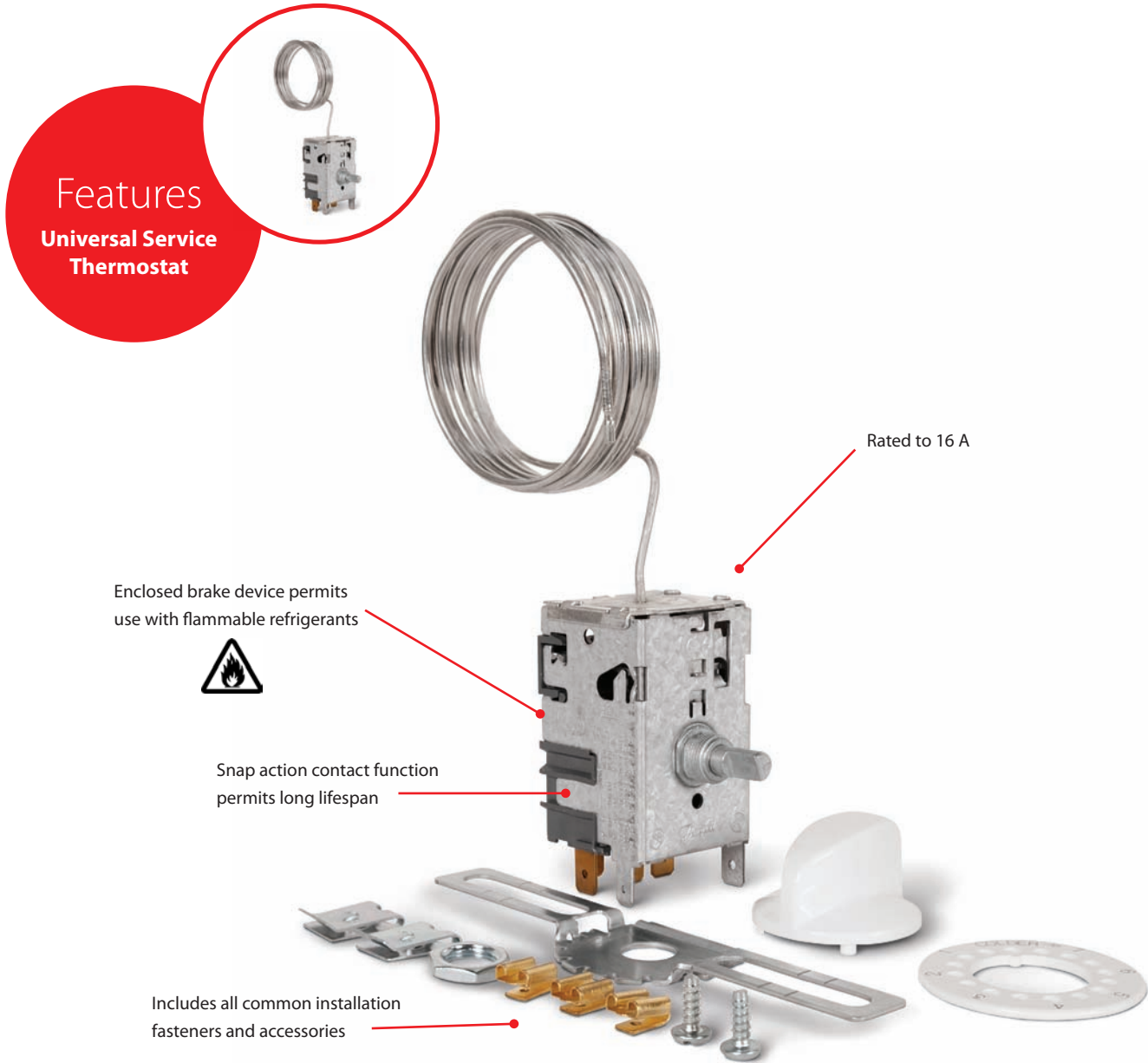

Features
Universal Service Thermostat

Enclosed brake device permits use with flammable refrigerants



Snap action contact function permits long lifespan

Rated to 16 A

Includes all common installation fasteners and accessories

Facts

Applications:

- Traditional refrigeration
- Self-contained refrigerators
- Reach-ins
- Bottle coolers
- Under counter refrigerators
- Eight kit options
- Fixed cut-in and constant differential options available
- Enclosed brake device permits use with flammable refrigerants
- Contact Load: 16 A (120V)

Kit includes:

- Thermostat
- Mounting bracket
- Adjustment knob
- Fasteners

Technical data and ordering



Universal Service Thermostat

Application	Operation mode	Temperature Range (°F)			Sensor type	Capillary tube length (in.)	Competitor Model No.	Danfoss Code No.
		Warm pos. cut-in/cut-out	Middle pos. cut-in/cut-out	Cold pos. cut-in/cut-out				
Refrigerator	Constant Cut-in	38/28	38/19	38/9	Coiled Bulb	39	A12-1506 A12-710 A12-711	077Z7010
Refrigerator	Constant Cut-in	41/29.5	41/23.5	41/17	Straight Sensor	84	A12-700 A12-701 A12-1560 A12-712	077Z7011
Refrigerator/ Freezer	Adaptable Constant Differential	36/26	21.5/9	3/-14	Straight Sensor	42	A30-180 A30-182 A30-184 A30-185	077Z7012
Refrigerator/ Freezer	Adaptable Constant Differential	36/26	21.5/9	3/-14	Straight Sensor	84	A30-181 A30-183 A30-260 A30-263	077Z7013
Low Temp. Freezer	Adaptable Constant Differential	16.5/7	4.0/-7.5	-11/-25.5	Straight Sensor	84	A30-301 A30-307	077Z7014
Low Temp. Freezer	Adaptable Constant Differential	9.5/3	-3/-11	-18.5/-29	Straight Sensor	42	A30-310 A30-311 A30-313	077Z7015
Low Temp. Freezer	Adaptable Constant Differential	9.5/3	-3/-11	-18.5/-29	Straight Sensor	84	A30-308 A30-314	077Z7016
Refrigerator	Adaptable Constant Differential	47/36.5	37.5/25.0	25.5/10.0	Straight Sensor	66	A22-391 A22-1112	077Z7017

All controls feature an enclosed brake device to permit use with flammable refrigerants and are kitted with adjustment knob, installation fasteners, and mounting bracket.

Contact Load	120V		240V	
	Full Load Amps	16A	8A	
	Locked Rotor Amps	96A	40A	

KPU - Pressure Switches

KPU pressure switches are designed to be contractor friendly and used in refrigeration and air-conditioning systems to protect the systems from excessively low suction or too high discharge pressure. They can also be applied to start and stop compressors and the

fans of air-cooled condensers. KPU pressure switches, in single and dual versions, cover a comprehensive range of applications and are designed for use with fluorinated and non-aggressive refrigerants. Most KPU pressure controls can be used with R-410A systems.

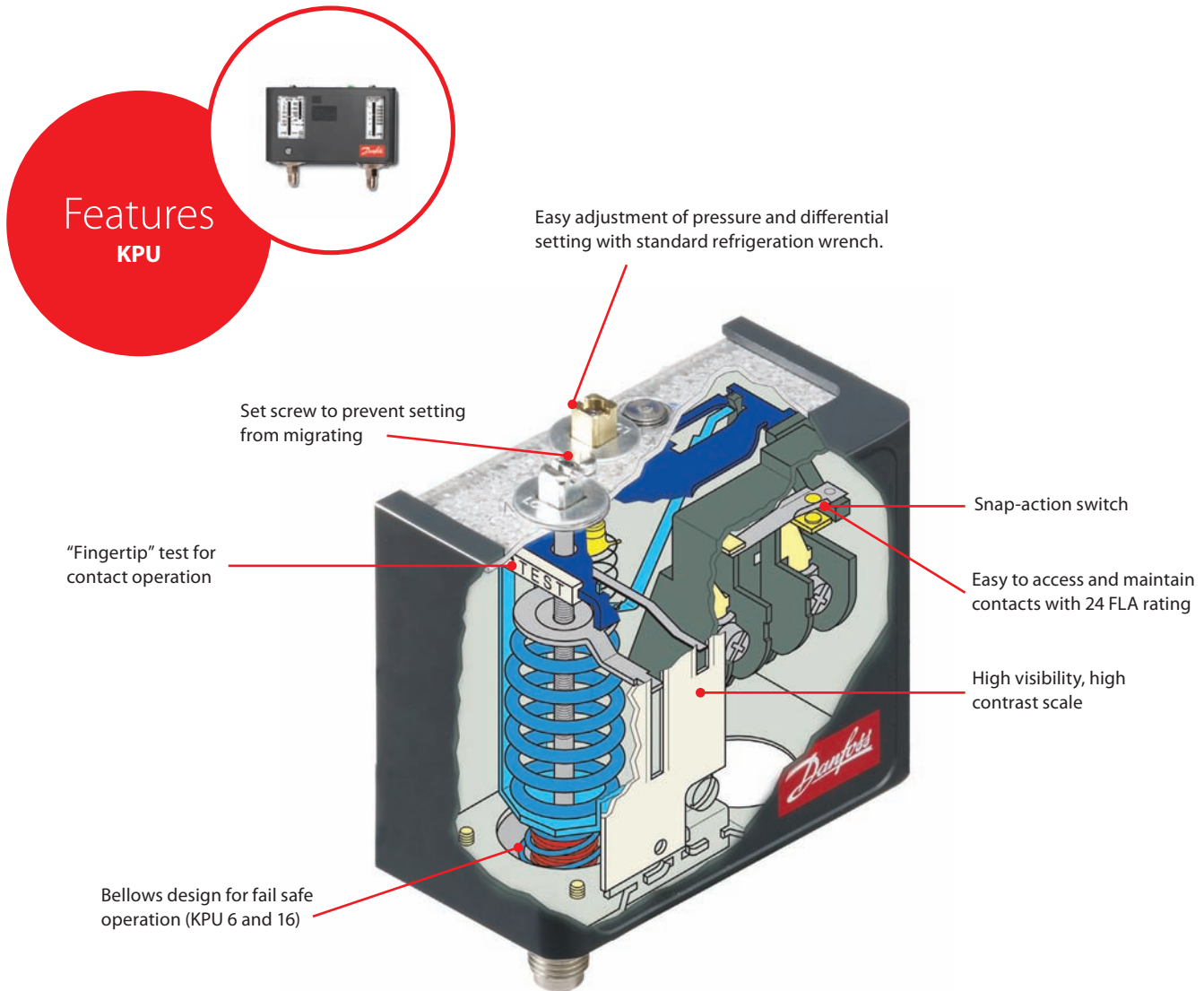

Facts

Applications:

- Commercial air conditioning
- Commercial refrigeration
- Supermarket Refrigeration
- Food processing and storage
- Product Types
 - Low Pressure
 - High Pressure
 - Dual Pressure
- Maximum working/test pressure
 - LP controls: 245/290 psig
 - HP controls: 505/505 psig
 - KPU 6 and 16 on HP side: 675/675 psig

- Refrigerants: R-22, R-134a, R-404A, R-407A, R-407C, R-407F, R-422B, R-422D, R-438A, R-448A, R-449A, R-450A, R-452A, R-507A, R-513A, R-410A (only KPU 1, 2, 6, 16)
- Ambient temperature: -40 to +150 °F (175 °F for max. 2 hours)
- Enclosure: NEMA 1
- Cable entry: 3/8 inch cable entry for 1/2 inch male pipe thread connection (conduit boss) or similar screwed cable entry
- Pressure connection: 1/4 inch M flare or 3/16 inch capillary tube with 1/4 inch flare nut
- KPU 6W, 6B, and 16B feature "dual bellows" on high pressure side to prevent leaks in the case of a bellows rupture

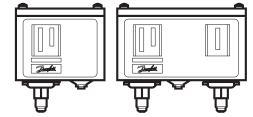

Technical data and ordering

KPU Pressure Switches

Danfoss Type	Pressure	Reset	Contact system	Range (in. Hg/psig)	Differential (psig)	Max. working pressure (psig)	Competitor part no. ¹	Danfoss Code No.	
								¼ in. M flare	36 in. capillary tubes with ¼ in. flare nuts
KPU 1	Low	Automatic	SPDT	6 to 108	10.2 to 58	250	O10-1483	060-5231	060-5233
KPU 2	Low	Automatic	SPST (NO)	6 to 73	6 to 30	250	O10-1402	060-5237	060-5235
KPU 2	Low	Automatic	SPDT	6 to 73	6 to 30	250		060-5239	060-5240
KPU1B	Low	Manual	SPDT	28 to 100	10.2	250	P70AB12 P70AB2	060-5232	060-5234
KPU 5	Fan cycling	Automatic	SPST (NO)	100 to 465	26.1 to 87	510	O10-2054 P70AA118	060-5241	060-5242
KPU 6W ²	High	Automatic	SPDT	100 to 600	58 to 145	675	O16-108	060-5243	060-5245
KPU 6B ²	High	Manual	SPDT	100 to 600	60	675		060-5244	060-5246

Danfoss Type	Low pressure side		High pressure side		Rest		Contact system (LP/HP)	Max. working pressure (low/high side) (psig)	Competitor part no. ¹	Danfoss Code No.	
	Range (in. Hg/psig)	Differential (psig)	Range (psig)	Differential (psig)	Low pressure side	High pressure side				¼ in. M flare	36 in. capillary tubes with ¼ in. flare nuts
KPU 15	6 to 108	10 to 60	100 to 465	60	Automatic	Automatic	SPST (NO/NC)	250/510	O12-1549	060-5247	060-5248
KPU 15B	6 to 108	10 to 60	100 to 465		Automatic	Manual	SPST (NO/NC)	250/510	P170LB1 P70LB1 P70MA1	060-5249	060-5250
KPU 16B	6 to 108	10 to 60	100 to 600		Convertible ³	Convertible ³	SPDT/ SPST (NO)	250/675	O12-4834	060-5253	060-5254

¹ Competitor part no. equipped with capillary tube for all but P170LB1 which has flare connections.

² KPU 6 and the high pressure side of KPU 16 are designed with fail-safe double bellows.

³ Convertible reset controls can be adjusted for either automatic or manual reset.

All controls are supplied with universal mounting bracket and mounting screws.

Ambient temperature: -40 °F to +122 °F (175 °F for maximum 2 hours).

KPU 1, 2, 6, 16 suitable for all HFC refrigerants, including R-410A.

See page 56 for capillary tube (code no. 060-017166) to connect to controls with ¼ in. male flare connections (pictured below).

120/240 VAC	
Alternating Current	
Motor Full Load Amps (FLA)	24
Locked Rotor Amps (LRA)	144
Direct Current	240 V DC: 12W pilot duty

KPU - Temperature Controls

KPU pressure controls are designed to be technician friendly and function as easy and direct replacements for most controls on the market. The KPU 60/70 temperature controls feature snap-action switches, highly visible contrast scales, fingertip tests, and are

easily adjustable using a standard refrigeration wrench. The KPU 19 temperature controls are designed for easy installation and service with bottom and rear knockouts, differential adjustment dial, a tamper-resistant design, and a robust thermoplastic housing.



Easy adjustment of temperature setting with hand knob (all but models with manual reset). Differential setting adjusted with standard refrigeration wrench. A set screw prevents settings from migrating.

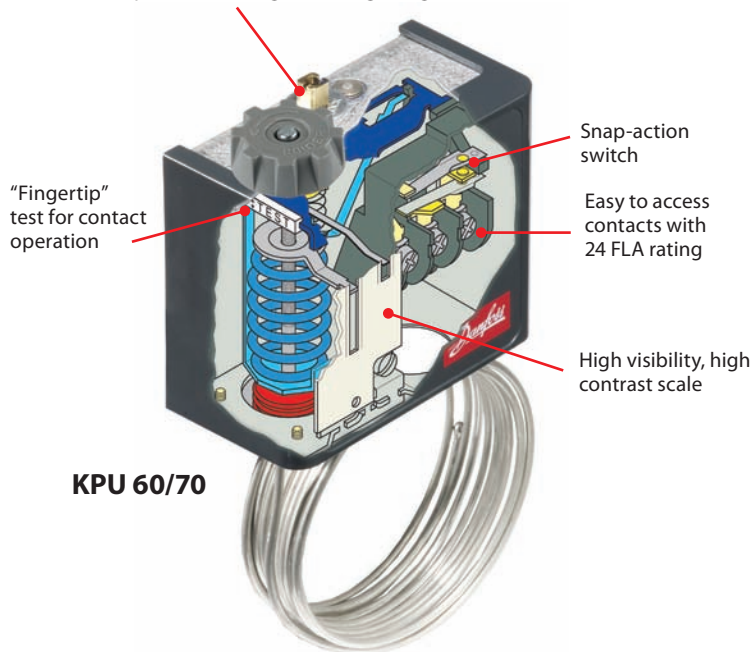

"Fingertip" test for contact operation

Snap-action switch

Easy to access contacts with 24 FLA rating

High visibility, high contrast scale

KPU 60/70

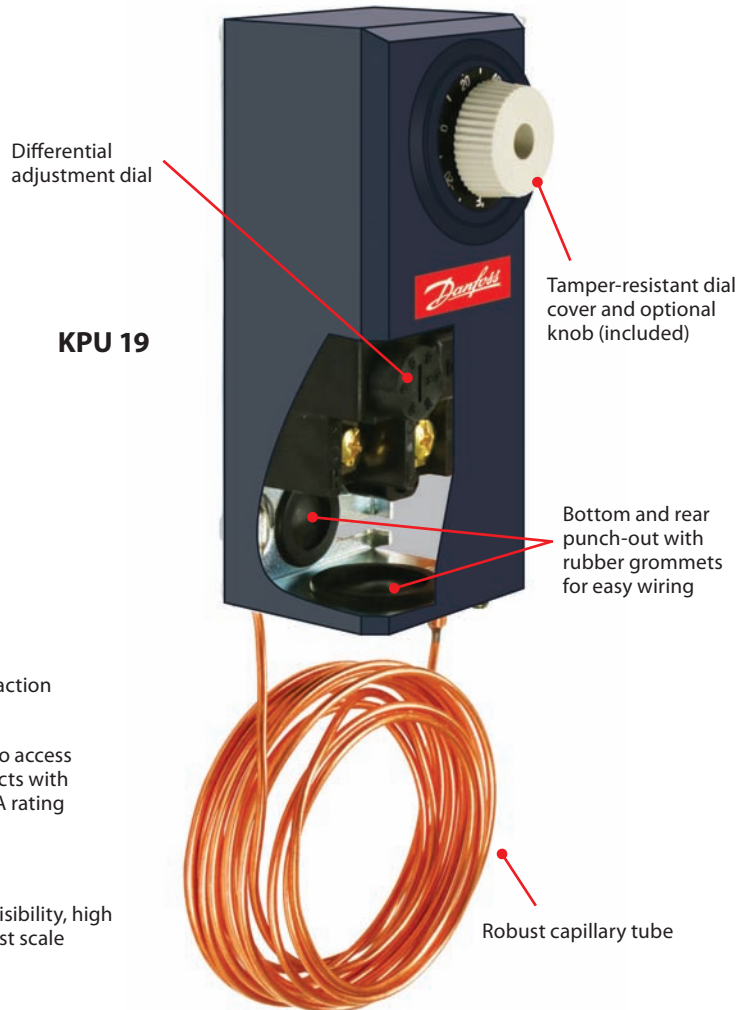

Differential adjustment dial

KPU 19

Tamper-resistant dial cover and optional knob (included)

Bottom and rear punch-out with rubber grommets for easy wiring

Robust capillary tube

Facts

Applications:

- Traditional refrigeration
 - Air conditioning
 - Ventilating systems
 - Heating systems
- KPU 60/70
 - Ambient temperature: -40 °F to +122 °F (175 °F for maximum 2 hours)
 - Switch: Single pole changeover switch (SPDT)
 - Enclosure: NEMA 1
 - Cable entry: 7/8 inch cable entry for 1/2 inch male pipe thread connection (conduit boss) or similar screwed cable entry
 - KPU 19
 - Ambient temperature: -30 °F to +158 °F (bulb sensor); -30 °F to +140 °F (room sensor)
 - Switch: Single pole changeover switch (SPDT) and single pole non-changeover switch (SPST)
 - Enclosure: NEMA 1
 - Cable entry: 7/8 inch cable entry for 1/2 inch male pipe thread connection (conduit boss) or similar screwed cable entry

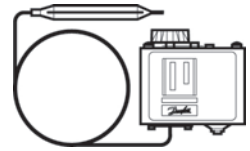

Technical data and ordering

KPU Temperature Controls

KPU Series	Bulb type	Range (°F)	Contact/Reset	Capillary tube length (in.)	Differential		Maximum bulb temperature (°F)	Competitor part no.	Danfoss Code No.
					at lowest temp. setting	at highest temp. setting			
KPU 61	Straight capillary tube ¹	-20 to 60	SPDT/Auto	80	10 to 40	2.5 to 13	250	O10-1416 O10-1010 O16-111 O10-1419	060L5201
KPU 61	Remote air coil ¹	-20 to 60	SPDT/Auto	80	8 to 40	2.5 to 13	250	O10-1408 O10-1409 O10-1473 O16-104 O10-1410	06L5203
KPU 62	Room sensor ¹	-20 to 60	SPDT/Auto	Room sensor	10 to 40	2.5 to 13	250	O10-1072 O10-1418 O16-594 O60-101	060L5206
KPU 68	Room sensor ¹	25 to 95	SPDT/Auto	Room sensor	8 to 45	3 to 13	250	O10-1802 O16-595 O10-301 O16-165	060L5215
KPU 73	Remote bulb ²	-15 to 60	SPDT/Auto	80	6.5 to 32	5 to 50	175	O60-100 O60-120	060L5208
KPU 71	Remote bulb ²	25 to 70	SPDT/Auto	80	5.5 to 18	4 to 16	175		060L5218
KPU 77	Remote bulb ²	60 to 140	SPDT/Auto	80	6 to 18	6.3 to 18	265	O60-200 A19AAF-12C A19AAB-4C A19ABB-2C A19ABB-7C	060L5223

¹ Bulb must be installed in colder position than thermostat housing and capillary tube.

² Temperature variations in excess of 70 °F between sensing bulb, housing, and capillary tube will influence scale accuracy.

Contact Load	Resistive load		24A/120V AC 24A/240V AC
	Inductive load	Full load	24A/120V AC 24A/240V AC
		Locked rotor	144A/120V AC 144A/240V AC
	Pilot duty		12W/120V DC



KPU Series	Bulb type	Range (°F)	Contact/Reset	Capillary tube length (in.)	Differential at lowest temp. setting	Maximum bulb temperature (°F)	Competitor part no.	Danfoss type	Danfoss Code No.
KPU 19	Remote bulb	-30 to 80	SPDT/Auto	120	3.6 to 12.6	140	A19ABC-24C A19ABC-37C A19ABC-74C A19AAC-4C A19AAF-20C	KPU19	060L2150¹
KPU 19		-30 to 80	SPST/Auto	80	3.6 to 12.6	140	A19AAD-5C A19ABA-40C A19AAD-12C	KPU19	060L2151¹
KPU 19	Room bulb	-30 to 80	SPDT/Auto	Room sensor	3.6 to 12.6	140	A19BBC-2C A19BAB-3C A19BAC-1C A19BAF-1C	KPU19	060L2152

¹ As 060L1250 is SPDT, 060L2150 can replace competitor parts crossed to both 060L2150 and 060L2151.

Contact Load	Resistive load		0.5~16A/120V AC 0.5~8A/240V AC
	Inductive load	Full load	0.5~16A/120V AC 0.5~8A/240V AC
		Locked rotor	96A/120V AC 48A/240V AC
	Pilot duty		125VA/240V DC

MP - Differential Pressure Switch / Lube Oil Protection Switch

MP 54 and MP 55 oil differential pressure switches are used to protect refrigeration compressors against low oil pressure. These switches are compatible with HCFC and non-flammable HFC refrigerants.

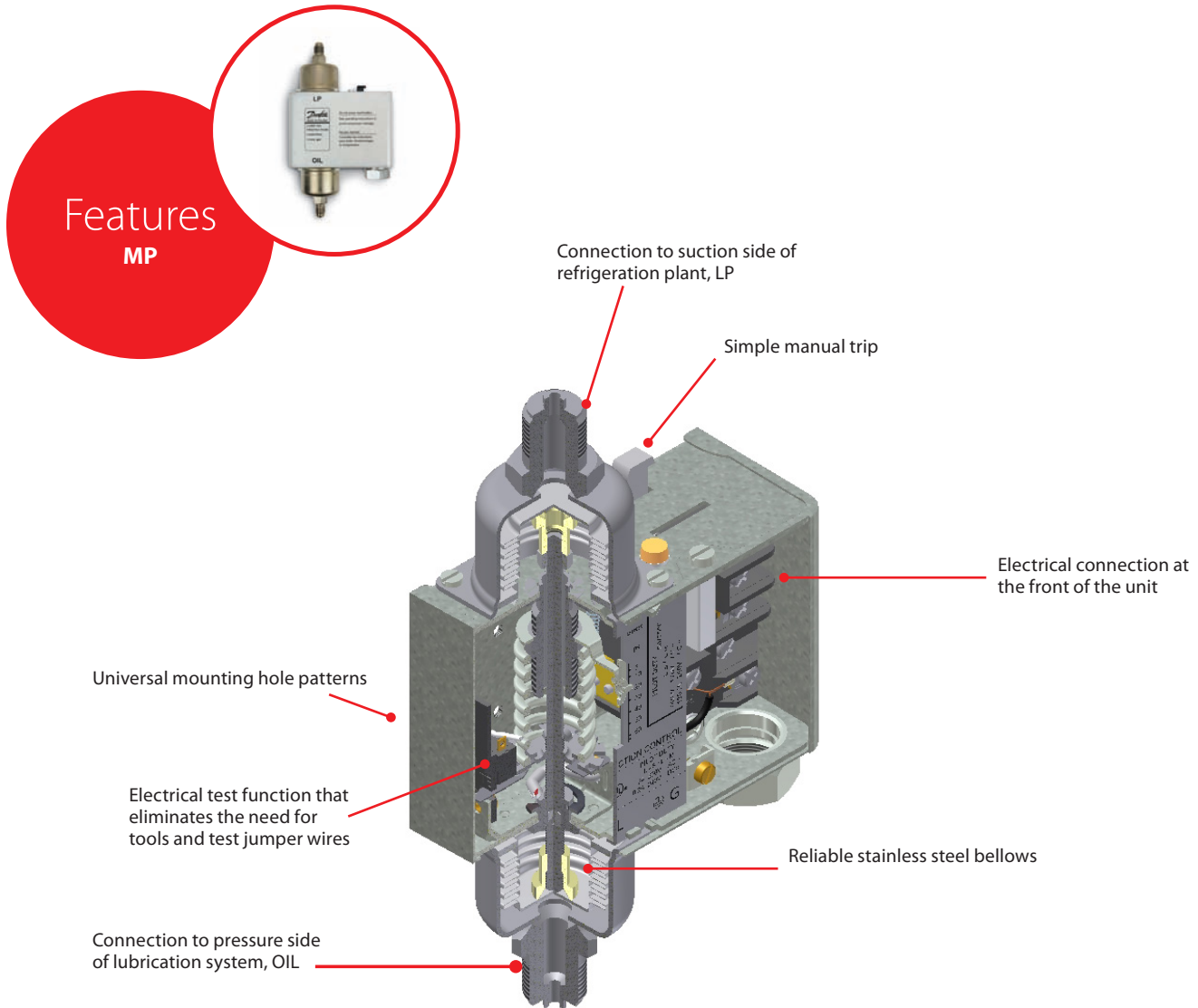

Facts

Applications:

- Commercial refrigeration
- Commercial air conditioning
- Supermarket Refrigeration
- Food processing and storage

- Product Types
 - Fixed Differential (MP 54)
 - Adjustable Differential (MP 55)
- Refrigerants: HCFC and non-flammable HFC refrigerants
- Max working/test pressure: 245 psig/320 psig
- Ambient temperature: The time relay is temperature-compensated in the range -40 °F to +140 °F
- Enclosure: ~NEMA 1
- Cable entry: Integral ½ inch female NPSM swivel cable connector for ½ inch male pipe thread connector.
- Pressure connection: ¼ inch M flare or 36 inch capillary tube with ¼ inch flare nut

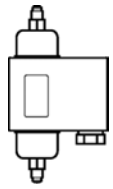

Technical data and ordering

MP - Differential Pressure Control / Lube Oil Protection Control

Danfoss Type	Control differential Δp (psig)	LP side Regulation range (in. Hg/psig)	Time relay delay time seconds	Competitor Code Nos.	Danfoss Code No.	Competitor Code Nos.	Danfoss Code No.
				¼ in. M flare		36 in. capillary tubes with ¼ in. flare nuts	
MP54	6	29 to 175	45	P145NCA/B-82C	060B200866	P45NCA-82C 3321-009	060B205066
	9	29 to 175	90	3321-001	060B200266		
	9	29 to 175	120	P145NCA/B-12C P31-5827 3321-001	060B200366²	P145NCA-12C P30-5826 3321-010	060B205366²
MP55	4.3 to 65	29 to 175	45			P288AA-18/2C P30-3601 3321-014/5 ³	060B205466
	4.3 to 65	29 to 175	60	P128AA-2C	060B201266¹		
	4.3 to 65	29 to 175	120	P128AA-17C	060B200766	P28AA-17C P28NA-5C P30-3801 3321-014/5 ³	060B205766

¹With glow lamp that remains on during normal operation of compressor.

Note: When time delay is energized which also means that min. permissible oil pressure (differential Δp) is reached, light goes out.

²Three-wire hook-up with jumper that is provided in the box with control.

³The 3321 series controls feature adjustable delay and fixed differential. The differential for 3321-014 controls is set at 15 psig and 3321-015 is at 30 psig. Select control with appropriate delay time.

Capillary tube (Code No. 060-017166) is available in the Spare Parts and Accessories section on page 56.

EVR - Solenoid Valves

EVR solenoid valves are direct or servo-operated solenoid valves for liquid, suction, and hot gas lines. They are suitable for all refrigeration, freezing, and air conditioning applications and are compatible with

fluorinated refrigerants. The valves can be delivered as normally open or closed as well as with or without manual operation.

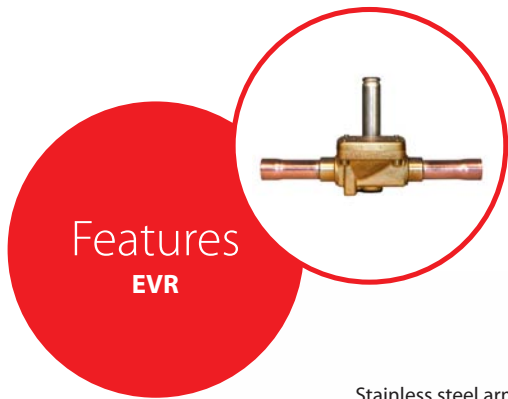

EVR

Features

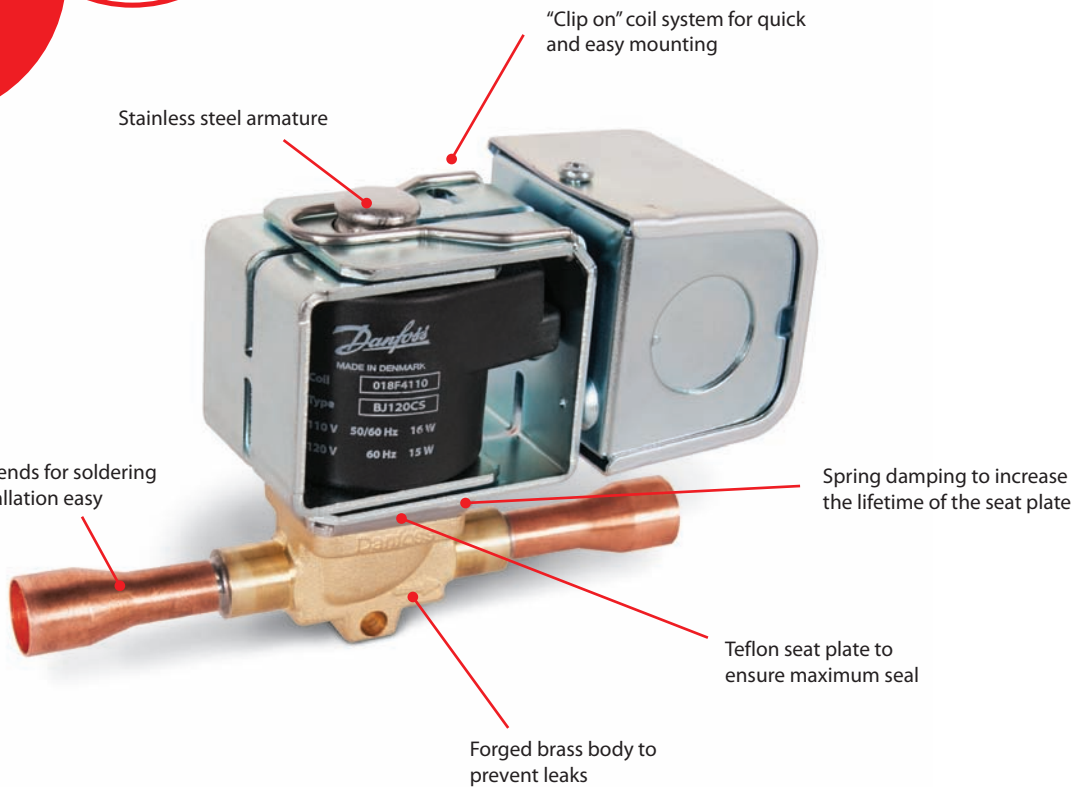

Facts

Applications:

- Traditional refrigeration
- Freezers
- Air conditioning units
- Commercial refrigeration
- Supermarket Refrigeration
- Refrigerants: Use with any fluorinated refrigerant
- Maximum working pressure:
 - EVR 2–EVR 8: 655 psig
 - EVR 10: 500 psig
 - EVR 15–EVR 40: 460 psig
- Temperature range: -40°F to $+220^{\circ}\text{F}$
- Connections:
 - Flare connections up to $\frac{5}{8}$ inch
 - Solder connections up to $2\frac{1}{8}$ inch
- Available in normally open and normally closed
- Available with or without manual stem
- Coil available with junction box (NEMA 2) and conduit boss (NEMA 4)

Technical data and ordering

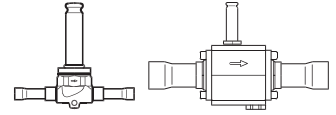

EVR Solenoid valves

Danfoss Type	Rated capacity (liquid tons)			Solder ODF connection (in.)	Port size (in.)	Max. working pressure (psig)	Danfoss Code No. ¹	
	R-22	R-134a	R-404A				with manual stem	without manual stem
	R-407C		R-507A					
EVR 3	2.03	1.55	1.40	¼	⅜	655		032F7105
EVR 3	2.03	1.55	1.40	⅜	⅜	655		032F1157
EVR 6	5.83	4.43	4.01	⅜	15/64	655	032F7116	032F7115
EVR 6	5.83	4.43	4.01	½	15/64	655	032F7144	032F1162
EVR 8	8.01	6.09	5.52	½	5/16	655	032F7148	032F7121
EVR 10	13.80	10.50	9.53	5/8	3/8	500	032F7149	032F1168
EVR 15	18.90	14.40	13.00	5/8	9/16	460		032F1171
EVR 18	24.60	18.70	17.00	7/8	19/32	460	032F1004	
EVR 20	36.40	27.70	25.10	7/8	7/8	460	032F1177	032F1176
EVR 22	43.70	33.30	30.10	1 1/8	15/16	460	032F7137	032F7145
EVR 25	72.80	55.40	50.20	1 3/8	1	400	032F1194	032F1193
EVR 32	116.50	88.70	80.30	1 5/8	7/8	400	042H1179	042H1178

¹ Valve body is normally closed (NC) and excludes coil. Additional code nos. available in Coolselector or contact Danfoss. Spare parts and accessories are available on pages 56.

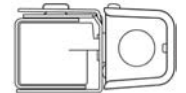

Coils

Voltage (V)	Frequency (Hz)	Power consumption (W)	Danfoss Type (junction box) ²	Length of wire (in.)	Danfoss Code no.	Danfoss Type (conduit boss) ³	Length of wire (in.)	Danfoss Code No.
24	50/60	14	BJ024CS	7	018F4100	BX024CS	18	018F4102
110	50/60	16	BJ120CS	7	018F4110	BX120CS	18	018F4112
120	60	15						
208–240	60	14	BJ240CS	7	018F4120	BX240CS	18	018F4122
230	50	17						

² Enclosure rating for BJ coils is NEMA 2/IP 30

³ Enclosure rating for BX coils is NEMA 4/IP 54

WVFX - Pressure Controlled Water Valves

Pressure controlled water valves type WVFX are used for regulating the flow of water in refrigeration systems with water cooled condensers. Water valves regulate water flow and thereby maintain constant condensing pressure. At shut-down, cooling water flow

is shut off automatically. WVFX valves are designed as wide-range, general purpose water valves, and are particularly popular among contractor customers.

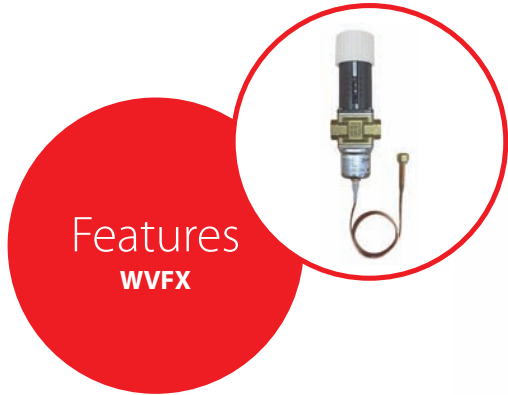

Features
WVFX

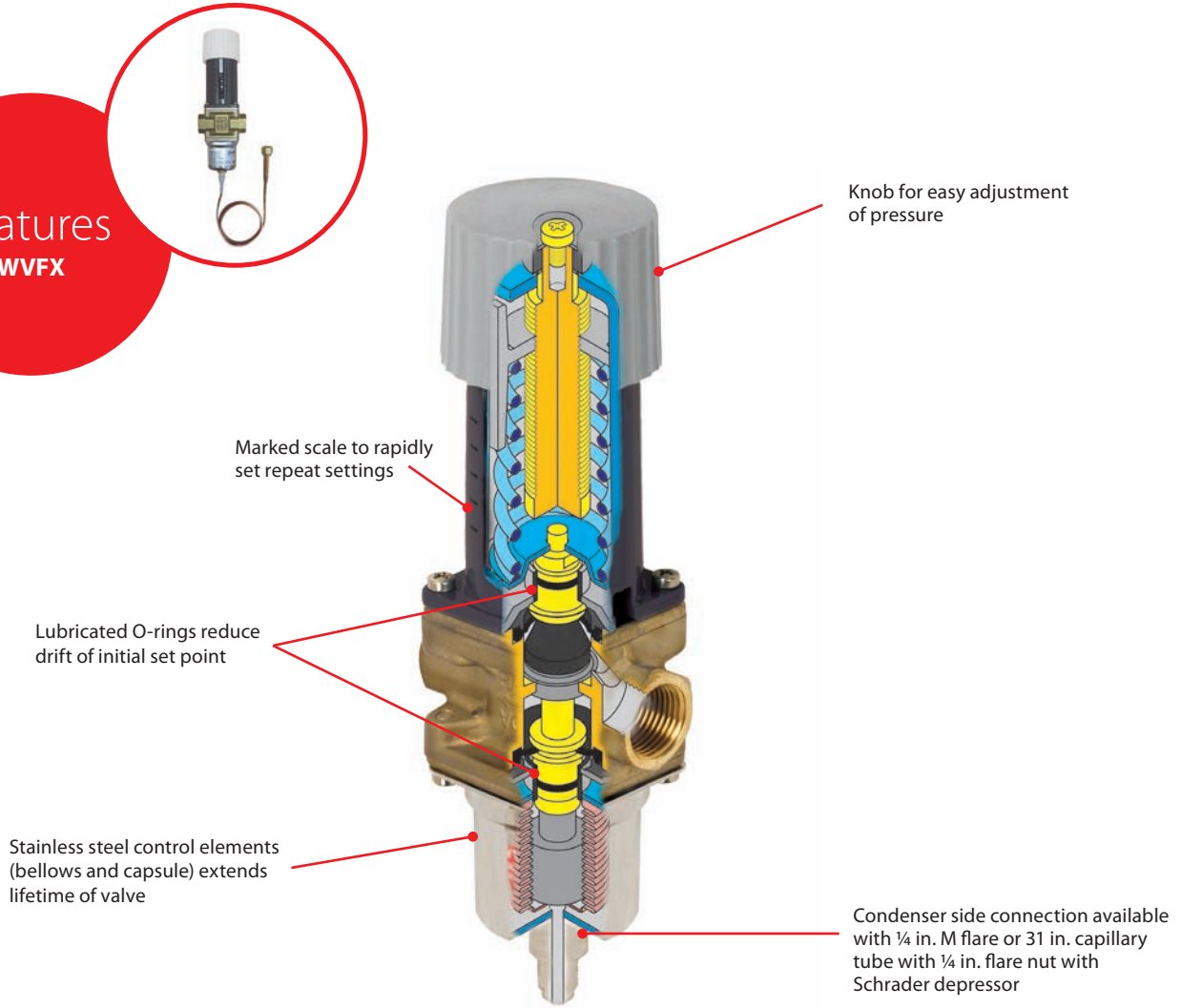

Facts

Applications:

- Refrigeration systems with water-cooled condensers
- Refrigerants: HCFC and HFC
- Connections
 - Water side: 3/8 inch to 1 inch (NPT)
 - Condenser side: 1/4 inch M flare or 31 inch capillary tube with 1/4 inch flare nut with Schrader depressor
- Max working/test pressure
 - Water side: 380/420 psig
 - Condenser side: 230/350 psig
- No need for power—self acting
- Opens on rising condensing pressure
- Insensitive to dirt



Technical data and ordering

WVFX - Pressure Controlled Water Valves

Danfoss Type	Competitor Part No.	Connection		Range (psig)	Condenser side		Water side		Flow coefficient, Cv valve (gal/min)	Danfoss Code No.
		Water side (NPT)	Condenser side		Maximum working pressure (psig)	Maximum test pressure (psig)	Maximum working pressure (psig)	Maximum test pressure (psig)		
WVFX 10	V46AA-1C ¹	3/8	1/4 in. M flare	60 to 333	380	420	230	350	1.6	003N5006
WVFX 10	V46AA-1C	3/8	31 in. capillary tube with 1/4 in. flare nut ²						1.6	003N5025
WVFX 15	V46AB-1C ¹	1/2	1/4 in. M flare						2.2	003N6006
WVFX 15	V46AB-1C	1/2	31 in. capillary tube with 1/4 in. flare nut ²						2.2	003N6025
WVFX 20	V46AC-1C ¹	3/4	1/4 in. M flare						3.9	003N7006
WVFX 20	V46AC-1C	3/4	31 in. capillary tube with 1/4 in. flare nut ²						3.9	003N7025
WVFX 25	V46AD-1C ¹	1	1/4 in. M flare						6.4	003N8006
WVFX 25	V46AD-1C	1	31 in. capillary tube with 1/4 in. flare nut ²						6.4	003N8025

¹ Competitor valve equipped with capillary tube as in code no. directly below. Else, see page 56 for capillary tube spare part (code no. 060-017166) to attach to this code no.

² Schrader depressor installed at end of capillary tube.

Length of valve from top of knob to bottom of control element is 8.07 in. for WVFX 10, 15, 20, and 8.46 in. for WVFX 25.

Temperature range: -13 to +265 °F

Maximum differential pressure: 145 psig

Spare parts and accessories are available on pages 56.

KVP/KVL/KVR/NRD/KVC/CPCE - Pressure Regulators

Danfoss has a variety of pressure regulators to control the low and high pressure sides and efficient function of a refrigeration system under varying load conditions.

Pressure regulators include:

- Evaporator Pressure Regulator (KVP)
- Crankcase Pressure Regulator (KVL)
- Condensing Pressure Regulator (KVR)
- Differential Pressure Regulator (NRD)
- Hot Gas Bypass Valves (KVC/CPCE)

KVP/KVL/KVR/
NRD/KVC/CPCE

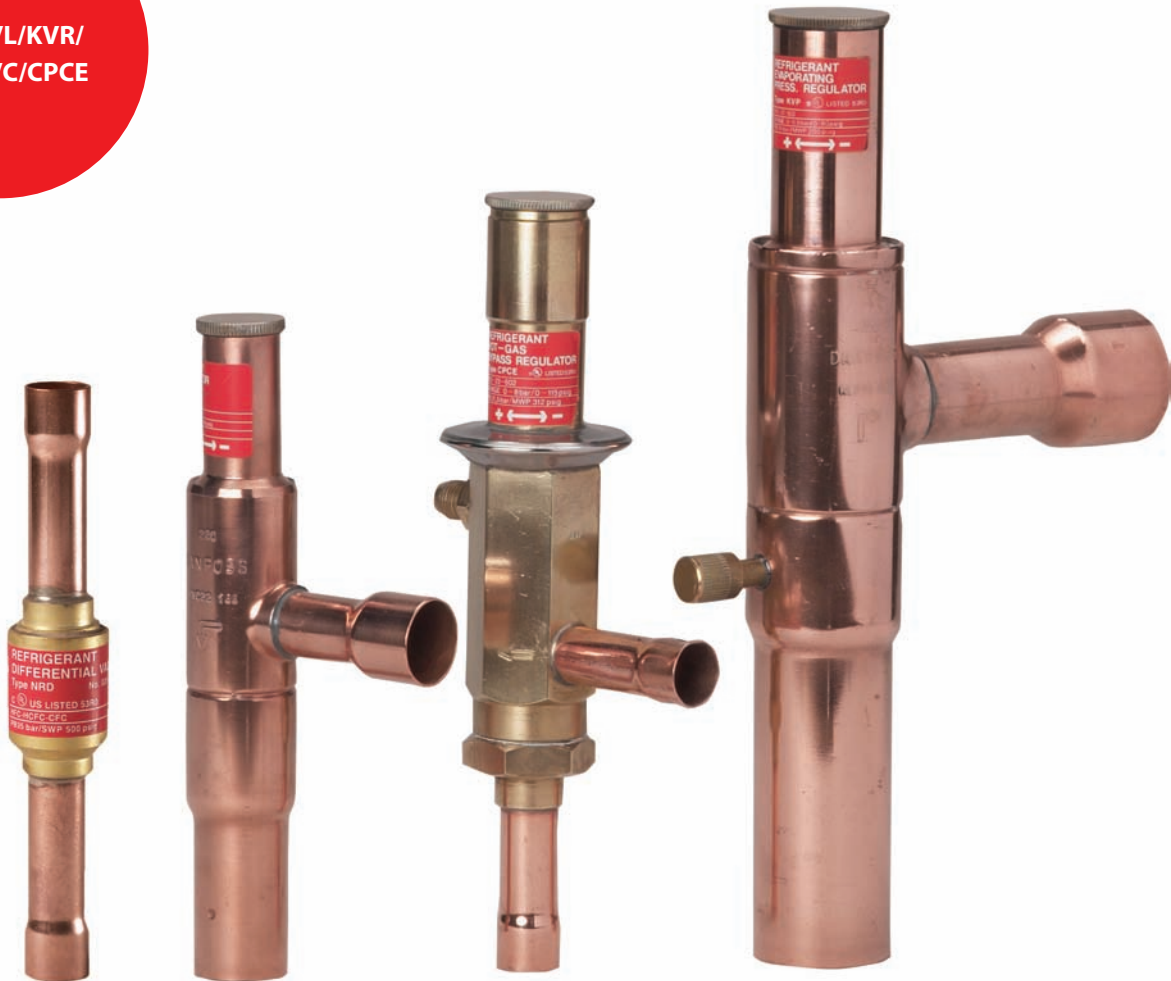

Facts

- All valves available for use with any CFC, HCFC, or HFC refrigerant, except R-410A
- Very stable and accurate pressure regulation
- Hermetic brazed construction 100% leak tested
- Available with flare and ODF solder connections
- Stainless steel bellows for extended lifetime
- Built-in valve seat dampening design
- Pressure regulation side
 - KVP/KVR—opens on a rising pressure
 - KVC/KVL—opens on a falling pressure

Technical data and ordering

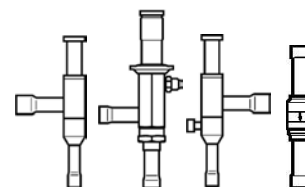

KVP/KVL/KVR/NRD/KVC/CPCE - Pressure Regulators

Application	Danfoss Type	Rated capacity (tons)				Solder ODF connection (in.)	Setting range (psig)	Factory setting (psig)	Maximum working pressure (psig)	Maximum test pressure (psig)	Minimum temp. of medium (°F)	Maximum temp of medium (°F)	Danfoss Code No.
		R-22	R-134a	R-404A	R-407C								
Evaporating Pressure Regulator	KVP 12	1.30	0.90	1.20	1.20	½	0 to 80	29	260	286	-50	265	034L0023
	KVP 15	1.30	0.90	1.20	1.20	¾	0 to 80	29	260	286	-50	265	034L0029
	KVP 22	1.30	0.90	1.20	1.20	¾	0 to 80	29	260	286	-50	265	034L0025
	KVP 28	2.80	1.90	2.40	2.60	1 ½	0 to 80	29	260	286	-50	265	034L0026
	KVP 35	2.80	1.90	2.40	2.60	1 ¾	0 to 80	29	260	286	-50	265	034L0032
Crankcase Pressure Regulator	KVL 12	1.20	0.80	1.00	1.10	½	3 to 87	29	260	286	-75	266	034L0043
	KVL 15	1.20	0.80	1.00	1.10	¾	3 to 87	29	260	286	-75	266	034L0049
	KVL 22	1.20	0.80	1.00	1.10	¾	3 to 87	29	260	286	-75	266	034L0045
	KVL 28	4.10	2.60	3.40	3.80	1 ½	3 to 87	29	260	286	-75	266	034L0046
	KVL 35	4.10	2.60	3.40	3.80	1 ¾	3 to 87	29	260	286	-75	266	034L0052
Condensing Pressure Regulator	KVR 12	Liquid: 12.70 Hot gas: 4.13	Liquid: 11.80 Hot gas: 3.03	Liquid: 8.20 Hot gas: 3.27	Liquid: 13.80 Hot gas: 4.50	½	73 to 254	145	406	450	-50	266	034L0093
	KVR 15	Liquid: 12.70 Hot gas: 4.13	Liquid: 11.80 Hot gas: 3.03	Liquid: 8.20 Hot gas: 3.27	Liquid: 13.80 Hot gas: 4.50	¾	73 to 254	145	406	450	-50	266	034L0097
	KVR 22	Liquid: 12.70 Hot gas: 4.13	Liquid: 11.80 Hot gas: 3.03	Liquid: 8.20 Hot gas: 3.27	Liquid: 13.80 Hot gas: 4.50	¾	73 to 254	145	406	450	-50	266	034L0094
	KVR 28	Liquid: 32.60 Hot gas: 10.93	Liquid: 30.20 Hot gas: 8.04	Liquid: 20.90 Hot gas: 8.66	Liquid: 35.50 Hot gas: 11.91	1 ½	73 to 254	145	406	450	-50	266	034L0095
	KVR 35	Liquid: 32.60 Hot gas: 10.93	Liquid: 30.20 Hot gas: 8.04	Liquid: 20.90 Hot gas: 8.66	Liquid: 35.50 Hot gas: 11.91	1 ¾	73 to 254	145	406	450	-50	266	034L0100
Differential Pressure Regulator	NRD 12s ¹					½	73 to 254	145	667	870	-50	266	020-1132
Hot Gas Bypass	KVC 12	2.14	1.36	2.02	2.31	½	3 to 87	29	406	450	-50	266	034L0143
	KVC 15	4.17	2.65	3.93	4.50	¾	3 to 87	29	406	450	-50	266	034L0147
	KVC 22	5.35	3.41	5.04	5.78	¾	3 to 87	29	406	450	-50	266	034L0144
	CPCE 12	6.20	4.30	6.30	6.70	½	0 to 87	5.8	406	450	-58	285	034N0082
	CPCE 15	9.20	6.30	9.10	9.90	¾	0 to 87	5.8	406	450	-58	285	034N0083
CPCE 22	12.20	8.40	12.10	12.20	¾	0 to 87	5.8	406	450	-58	285	034N0084	

¹ NRD generally used in conjunction with a KVR to regulate the condensing pressure
Spare parts and accessories are available on pages 56.

DCL/DCB/DAS/DCR - Filter Driers

Danfoss filter driers function as simple drop-in replacements for most driers sold in the aftermarket or installed on equipment by manufacturers. All Danfoss filter driers are constructed with a solid core design to maximize moisture removal while minimizing pressure

drop. These driers use a mixture of molecular sieve and activated alumina to both adsorb system moisture and capture acid and prevent solid contaminants from entering the system.

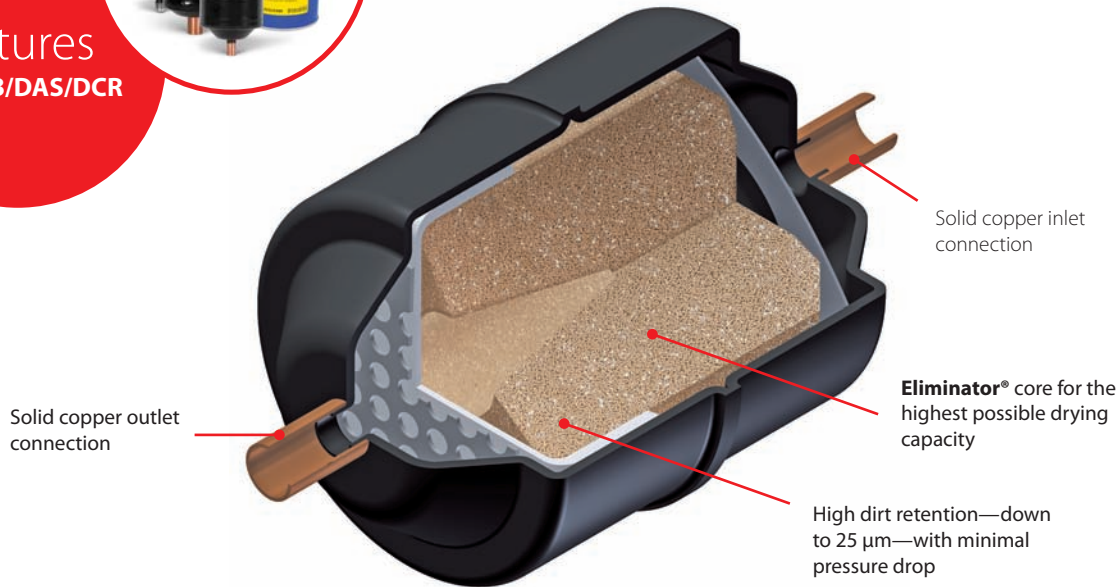

Nomenclature / Model No.

D A S 16 4 s VV

- D**: Filter drier
- A**: Solid Core
 - A**: Core with 30% molecular sieve/ 70% activated alumina (burn-out)
 - C**: Core with 80% molecular sieve/ 20% activated alumina
 - M**: Core with 100% molecular sieve
- S**: Application
 - B**: Bi-flow
 - L**: Liquid line
 - S**: Suction line
- 16**: Size (volume)
 - 1.5**: 1.5 in.³
 - 03**: 3 in.³
 - 05**: 5 in.³
 - 08**: 8 in.³
 - 16**: 16 in.³
 - 30**: 30 in.³
 - 41**: 41 in.³
 - 60**: 60 in.³
 - 75**: 75 in.³
- 4**: Connection (filter connection in 1/8 in. increments)
 - 2/CAP**: 1/4 in. inlet x cap tube outlet
 - 2**: 1/4 in.
 - 2.5**: 5/16 in.
 - 3**: 3/8 in.
 - 4**: 1/2 in.
 - 5**: 5/8 in.
 - 6**: 3/4 in.
 - 7**: 7/8 in.
 - 9**: 1 1/8 in.
- s**: Connection type
 - (blank)**: Flare connection
 - s**: Solder connection
- VV**: Access valves

	Inlet	Outlet
(blank)	none	none
V	Schrader valve	none
VV	Schrader valve	Schrader valve

Technical data and ordering

DCL/DCB Liquid Line/Bi-flow Filter Driers

Danfoss Type	Connection (in.)	Max. working pressure (psig)	Drying capacity (lbs. of refrigerant)								Liquid capacity (tons)				Danfoss Code No.
			R-134a		R-404A		R-22		R-410A		R-134a	R-404A	R-22	R-410A	
			75°F	125°F	75°F	125°F	75°F	125°F	75°F	125°F					
DCL 1.52/2.8mms	¼ solder	667	5.10	4.60	5.30	5.10	5.10	4.60	4.60	4.20	0.80	0.50	0.90	0.80	023Z8255
DCL 032s	¼ solder	667	8.50	8.00	9.10	8.70	8.60	8.00	7.80	7.20	1.90	1.42	2.12	2.11	023Z5013 ¹
DCL 032	¼ flare	667	8.50	8.00	9.10	8.70	8.60	8.00	7.80	7.20	1.90	1.42	2.12	2.11	023Z5000 ¹
DCL 052s	¼ solder	667	13.60	12.80	14.60	13.80	13.80	12.70	12.40	11.40	2.18	1.60	2.40	2.37	023Z5018
DCL 052	¼ flare	667	13.60	12.80	14.60	13.80	13.80	12.70	12.40	11.40	2.18	1.60	2.40	2.37	023Z5002
DCL 053s	⅜ solder	667	13.60	12.80	14.60	13.80	13.80	12.70	12.40	11.40	3.66	2.79	4.10	4.15	023Z5019
DCL 053	⅜ flare	667	13.60	12.80	14.60	13.80	13.80	12.70	12.40	11.40	3.66	2.79	4.10	4.15	023Z5003
DCL 082s	¼ solder	667	21.70	20.50	23.30	22.10	22.00	20.30	19.80	18.20	2.18	1.55	2.37	2.28	023Z5022
DCL 082	¼ flare	667	21.70	20.50	23.30	22.10	22.00	20.30	19.80	18.20	2.18	1.55	2.37	2.28	023Z5004
DCL 083s	⅜ solder	667	21.70	20.50	23.30	22.10	22.00	20.30	19.80	18.20	4.03	3.12	4.56	4.65	023Z5023
DCL 084s	½ solder	667	21.70	20.50	23.30	22.10	22.00	20.30	19.80	18.20	8.14	6.07	9.03	8.99	023Z5026
DCL 084	½ flare	667	21.70	20.50	23.30	22.10	22.00	20.30	19.80	18.20	8.14	6.07	9.03	8.99	023Z5006
DCL 162	¼ flare	667	47.70	45.10	51.30	48.60	48.30	44.70	43.50	40.10	2.18	1.54	2.36	2.28	023Z5007
DCL 163s	⅜ solder	667	47.70	45.10	51.30	48.60	48.30	44.70	43.50	40.10	4.64	3.18	4.95	4.67	023Z5029
DCL 163	⅜ flare	667	47.70	45.10	51.30	48.60	48.30	44.70	43.50	40.10	4.64	3.18	4.95	4.67	023Z5008
DCL 164s	½ solder	667	47.70	45.10	51.30	48.60	48.30	44.70	43.50	40.10	9.15	6.69	10.07	9.90	023Z5032
DCL 165s	⅝ solder	667	47.70	45.10	51.30	48.60	48.30	44.70	43.50	40.10	12.69	10.41	14.74	15.59	023Z5033
DCL 165	⅝ flare	667	47.70	45.10	51.30	48.60	48.30	44.70	43.50	40.10	12.69	10.41	14.74	15.59	023Z5010
DCL 303s	⅜ solder	667	100.50	95.00	108.00	102.40	101.80	94.10	91.60	84.40	4.46	3.00	4.72	4.40	023Z0030
DCL 303	⅜ flare	667	100.50	95.00	108.00	102.40	101.80	94.10	91.60	84.40	4.46	3.00	4.72	4.40	023Z0012
DCL 304s	½ solder	667	100.50	95.00	108.00	102.40	101.80	94.10	91.60	84.40	9.24	7.11	10.41	10.58	023Z0031
DCL 304	½ flare	667	100.50	95.00	108.00	102.40	101.80	94.10	91.60	84.40	9.24	7.11	10.41	10.58	023Z0013
DCL 305s	⅝ solder	667	100.50	95.00	108.00	102.40	101.80	94.10	91.60	84.40	13.00	10.51	14.99	15.72	023Z0032
DCL 305	⅝ flare	667	100.50	95.00	108.00	102.40	101.80	94.10	91.60	84.40	13.00	10.51	14.99	15.72	023Z0014
DCL 307s	⅞ solder	667	100.50	95.00	108.00	102.40	101.80	94.10	91.60	84.40	18.27	15.34	21.44	23.05	023Z0034
DCL 415s	⅝ solder	667	139.50	131.90	150.00	142.20	141.30	130.70	127.30	117.30	15.78	11.9	17.61	17.66	023Z0105
DCL 417s	⅞ solder	500	139.50	131.90	150.00	142.20	141.30	130.70	127.30	117.30	18.98	16.01	22.32	24.08	023Z0106
DCL 607s	⅞ solder	667	200.90	189.90	216.00	204.80	203.50	188.20	183.30	168.90	19.93	19.94	25.16	30.71	023Z0036
DCB 083s	⅜ solder	667	15.60	14.70	16.70	15.80	15.60	14.50	14.10	13.00	2.10	1.50	2.30	2.30	023Z1433
DCB 163s	⅜ solder	667	29.30	27.70	31.50	29.90	29.70	27.50	26.80	24.60	5.10	3.70	5.70	5.70	023Z1437
DCB 164s	½ solder	667	29.30	27.70	31.50	29.90	29.70	27.50	26.80	24.60	8.00	5.70	9.10	9.10	023Z1436
DCB 165s	⅝ solder	667	29.30	27.70	31.50	29.90	29.70	27.50	26.80	24.60	10.60	8.30	11.40	11.40	023Z1435

¹ Wire mesh in filter drier outlet.

DAS Suction Line Filter Driers

Danfoss Type	Connection (in.)	Max. working pressure (psig)	Rated capacity (tons)			Acid capacity (oz.)	Danfoss Code No.
			R-134a	R-404A	R-22		
					R-410A		
DAS 164sVV	½ solder	500	1.70	2.40	6.30	0.30	023Z1009
DAS 165sVV	⅝ solder		2.70	3.70	4.30	0.30	023Z1010
DAS 166sVV	¾ solder		3.40	4.90	5.70	0.30	023Z1011
DAS 167sVV	⅞ solder		3.90	5.40	6.30	0.30	023Z1012
DAS 306sVV	¾ solder		4.00	5.40	6.30	0.64	023Z1014
DAS 307sVV	⅞ solder		4.60	6.30	7.40	0.64	023Z1015
DAS 309sVV	1½ solder		5.70	7.70	8.90	0.64	023Z1016
DAS 419sVV	1½ solder		6.30	8.60	10.00	0.86	023Z1018

DCR Filter Drier Cores

Danfoss Type	Material	Danfoss Code No.
DCR core insert, type 48-DM solid core	100% molecular sieve	023U1392
DCR core insert, type 48-DC solid core	80% molecular sieve & 20% activated alumina	023U4381
DCR core insert, type 48-DA solid core	30% molecular sieve & 70% activated alumina	023U5381
DCR core insert, type 48-F strainer		023U1921

DCL with Schrader valve - Filter Driers

The new Danfoss capillary tube filter driers include a Schrader valve, making servicing the system easy and convenient, and convertible outlet for fitting on capillary tube or ¼ inch system connection.

Thanks to the solid core, Danfoss ELIMINATOR® filter driers offer exceptional drying capacity to protect the system against harmful acids and moisture.



Facts

Applications:

- Traditional refrigeration
- Air conditioning units
- Transport refrigeration
- Connections:
 - Inlet: ¼ inch solder and ¼ inch service port
 - Outlet: Capillary tube outlet can be trimmed down to ¼ inch
- Refrigerants: R-22, R-32, R-134a, R-404A, R-410A, R-407C/F, R-23, R-600, R-600a, R-1234yf, R-1234ze, R-290, R-452A, R-444B, R-449A, R-448A, R-450A, R-507. For other refrigerants, please contact Danfoss.
- Available with 1.5, 3, and 5 cubic inch solid core volumes
- 80% molecular sieve and 20% activated alumina core

Technical data and ordering

DCL with Schrader valve - Filter Drier

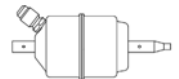

Danfoss Type	Connection inlet (in.)/ outlet	Max. working pressure (psig)	Drying capacity (lbs. of refrigerant)										Liquid capacity (tons)					Danfoss Code No.
			R-134a		R-404A		R-22		R-407C		R-410A		R-134a	R-404C	R-22	R-407C	R-410A	
			75°F	125°F	75°F	125°F	75°F	125°F	75°F	125°F	75°F	125°F						
DCL 1.52/ CAPSV	¼/capillary tube	667	5.2	4.8	5.5	5.2	5.3	4.9	5.1	4.7	4.7	4.2	1.0	0.7	1.1	1.0	1.0	023Z8261
DCL 032/ CAPSV	¼/capillary tube	667	8.4	7.7	8.8	8.3	8.5	7.8	8.2	7.6	7.6	6.8	1.2	0.8	1.3	1.2	1.2	023Z5174
DCL 052/ CAPSV	¼/capillary tube	667	13.5	12.4	14.1	13.4	13.6	12.5	13.1	12.1	12.3	10.9	1.2	0.8	1.3	1.2	1.2	023Z5181

GBC - Ball Valves

Danfoss GBC ball valves are manually operated shut-off valves suitable for bi-directional flow. The design, weld, and choice of the sealing material enable these ball valves to meet the most demanding requirements.

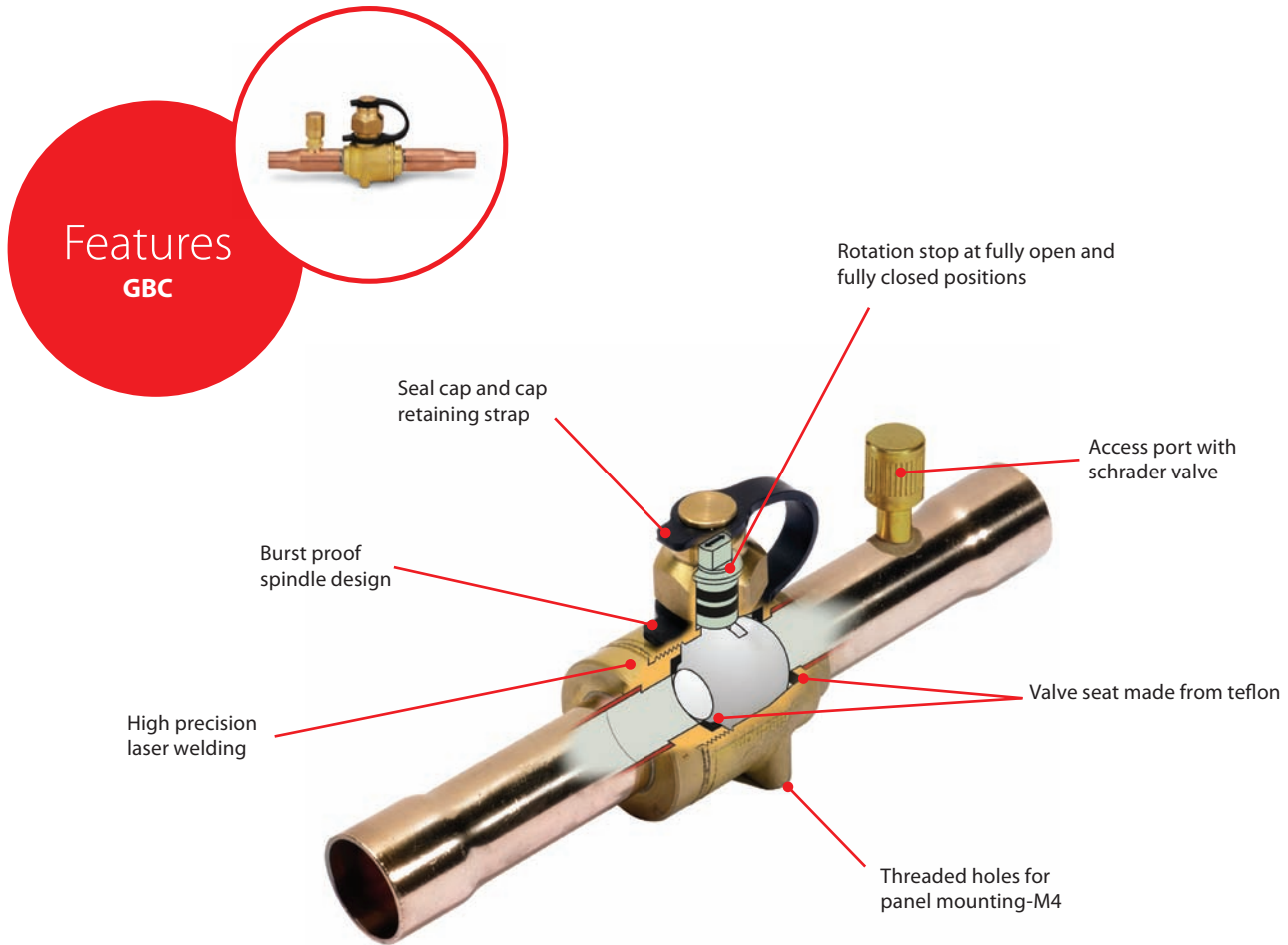

Product Selection

Danfoss Type	Solder ODF connection (in.)	Flow Coefficient, C _v value (gal/min)	Working pressure (psig)	Test pressure (psig)	Danfoss Code No.
GBC 6s	¼	2.27	650	940	009G8050
GBC 10s	⅜	6.57		940	009G8051
GBC 12s	½	12.23		940	009G8052
GBC 16s	⅝	16.31		940	009G8053
GBC 18s	¾	23.61		940	009G8054
GBC 22s	7/8	32.56		940	009G8065
GBC 28s	1 ⅛	60.05		940	009G8066
GBC 35s	1 ⅜	93.51		940	009G8067
GBC 42s	1 ½	139.96		940	009G8068
GBC 54s	2 ⅛	260.05		940	009G8059
GBC 67s	2 ⅝	358.36		725	009G8069

All valves listed in table above are Full Port.
Spare parts and accessories are available on pages 56.

SGP - Sight Glasses

Danfoss sight glasses are designed to accurately indicate the presence of moisture in refrigeration and air-conditioning systems. When system moisture content rises above permissible levels, the “dry/green” indicator will change to yellow indicating a “wet” system.

The indication of dangerous moisture levels is essential in helping prevent the formation of harmful acids which are detrimental to the system.

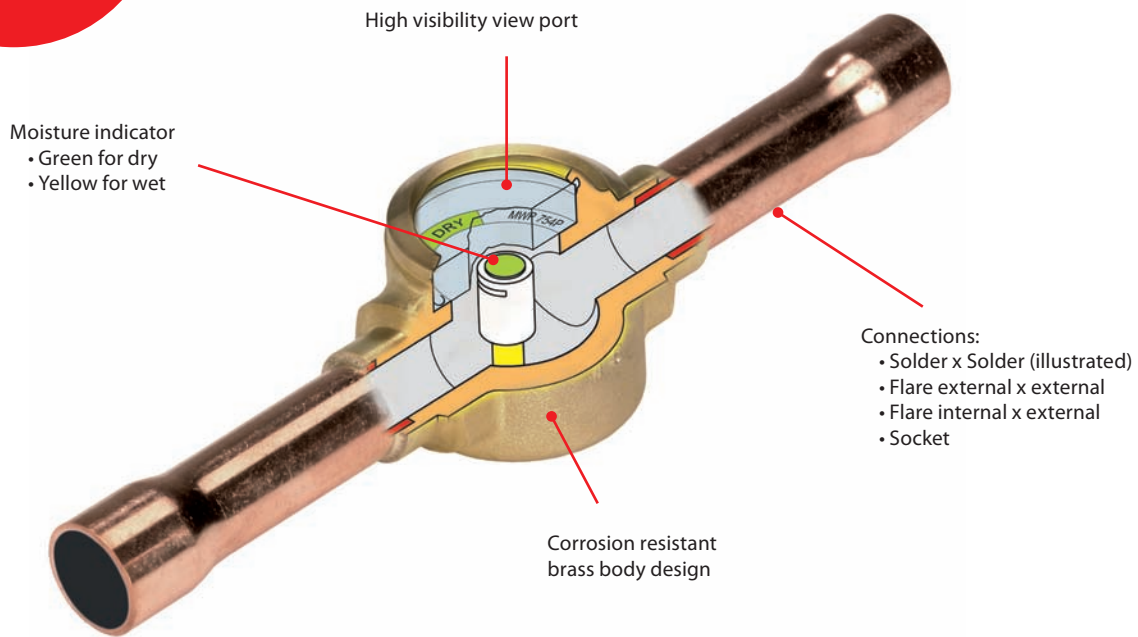

Product Selection

Danfoss Type	Version	Connection (in.)	Ambient temperature (°F)	Maximum working pressure (psig)	Danfoss Code No.
SGP 6 N	Flare int. x ext. ¹	¼ x ¼	-60 to 175	750	014L0171
SGP 10 N		⅜ x ⅜			014L0172
SGP 12 N		½ x ½			014L0173
SGP 6s N	ODF x ODF solder	¼ x ¼			014L0181
SGP 10s N		⅜ x ⅜			014L0182
SGP 12s N		½ x ½			014L0183
SGP 16s N		⅝ x ⅝			014L0145
SGP 22s N		⅞ x ⅞			014L0186
SGP ½ RN	NPT	½			

¹ Can be screwed directly onto Danfoss filter drier.

Light Commercial Compressors

Specially optimized for use in mobile, household, and light commercial applications, these hermetic reciprocating compressors provide high cooling capacity in an energy-saving design. Compressors are available for R-134a and R-404A.

Features Light Commercial Compressors



Technical data and ordering

Light Commercial Compressors (R-134a)

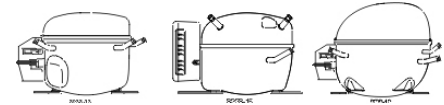

Voltage/ Phase/ Frequency	Horsepower rating (HP) ¹	HS/ LS	Competitor Model Nos.	Danfoss Model No.	Danfoss Standard Code No. Alternate Code No.	Cooling Capacity (Btu/h) ²									Danfoss Single Packed Code No. ³
						LBP Evaporator Temperature (°F)			MBP Evaporator Temperature (°F)			HBP Evaporator Temperature (°F)			
						-30	-13	0	0	+20	+40	+25	+45	+50	
12-24 DC, 100-240/1/ 50/60	multispeed			BD35F	101Z0204 101Z0200	194	299	221	421						195B0679
12-24 DC, 100-240/1/ 50/60	multispeed			BD50F	101Z0203 101Z1220	242	370	305	545						195B0678
115/1/60	1/40	LS		TL2.5G	102G3257	226	340	249	495	860	575	970	1087	195B0592	
115/1/60	1/40+	HS	AZA0370YXA AEA3414YXA EMIS30HHR EM30HHR	TL4G	102G3460 102G3462	320	516	393	732	1225	840	1375	1530	195B0003	
115/1/60	1/4	HS	AFE05C4E-IAA ARE25C4E-IAA ARE25C3E-SAA ARE25C3E-IAA AEA1360YXA AEA3425YXA AE3425YAA1A FF7.5HBK	NF5.5FX	105G5623	374	701	10355	845	1442	2293	1633	2562	195B0259	
115/1/60	1/4	HS	AFE07C3E-IAA ARE27C3E-SAA AEA3430YXA AEA4430YXA AE3430YAA1A AE4430YAA1A FF8.5HBK FF10HBX	NF7FX	105G5723	465	830	1206	1022	1708	2700	1925	3006	195B0467	
115/1/60	1/2	HS	ARE37C3E-SAA ARE34C4E-IAA AFE10C3E-IAA AEA3440YXA AEA4440YXA AE3440YAA1A AE4440YAA1A FF10HBX NEK6187Z	NF11FX	105G5945 105G5941 195B0330 105G5946	553	1046	1568	1333	2279	3638	2575	4056	195B0388	
115/1/60	1/2+	HS	AFE12C3E-IAA ARE41C3E-IAA ARE40C4E-IAA ARE46C4E-IAA AEA4448YXA AEA2410YXA AE4450YAA1A FF112HBX NEK6210Z	SC12G	104G7250	499	1126	1769	1344	2536	4242	2908	4765	5333	195B0042
115/1/60	1/2+	HS	AFE12C4E-IAA AKA4460YXA NEK6212Z	SC15G	104G7550	1266	2059	1556	3040	4969	3473	5544	6162	195B0099	
115/1/60	1/2+	HS	ARE51C4E-CAA AEA2413YXA AKA4476YXA NEK6214Z NT6215Z	SC18G	104G7800 195B0276	1582	2462	1882	3479	5586	3950	6217	6896	195B0694	
220-240/1/60	1/2+	HS	AKA4460YXD NEK6214Z	SC18G	104G8820	1526	2386	2006	3554					195B0059	
220-240/1/60	3/4	HS		SC21G	104G8140	1723	2665	2064	3960					195B0636	
208-230/1/60	5/8	HS	AKA4476YXD	GX23TG	123B1548	2088	3237	2549	4617	7459	5255	8290	9168	123B1548	
208-230/1/60	3/4	HS	AJA4492YXD	GS26TG	123B1550	1909	3578	2521	5298	8942	6128	9987	11080	123B1550	
208-230/1/60	1	HS	AJA4512YXD	GS30TG	123B1553	2150	3874	2811	6030	10550	7039	11880	13300	123B1553	
208-230/1/60	3/4	HS	AJA7461YXD	GS34TF	123B1590	3198	5439	3921	7588	12310	8671	13660	15070	123B1590	

¹ Horsepower ratings are nominal. Danfoss recommends sizing compressors based on cooling capacity requirements.

² Capacity at ASHRAE conditions below. For other conditions and/or speeds, check Coolselector or contact Danfoss.

³ Code no. contains compressor and required electrical and non-electrical accessories.

Full range of models (refrigerant, capacity, and voltage codes) available. Check Coolselector or contact Danfoss.

Technical data and ordering

Light Commercial Compressors (R-404A)

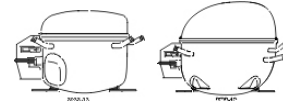

Voltage/ Phase/ Frequency	Horsepower rating (HP) ¹	HS/ LS	Competitor Model Nos.	Danfoss Model No.	Danfoss Standard Code No. Alternate Code No.	Cooling Capacity (Btu/h) ²									Danfoss Single Packed Code No. ³			
						LBP Evaporator Temperature (°F)			MBP Evaporator Temperature (°F)			HBP Evaporator Temperature (°F)						
						-30	-13	0	0	+20	+40	+25	+45	+50				
115/1/60	1/5	HS	AFE06C4E-IAA ASE12C4E-IAA AEA9415ZX	TF4CLX	102U2114 102U2102 195B0468	421	714	1008	791	1285	1953							195B0666
115/1/60	1/4	HS	ASE14C4E-IAA AFE08C4E-IAA AEA2380ZX	TFS4.5CLX	102U2115	569	933	1297										195B0667
115/1/60	1/3	HS	AE4430ZAA1A AEA9422ZX AKA9427ZX NEK2121GK NEK2125GK	NF5.5CLX	105F1621	789	1276	1759	1384	2209	3334							195B0348
115/1/60	1/3+	HS	AFE13C4E-IAA ASE20C4E-IAA AEA2411ZX AE4440ZAA1A AE2410ZAA1A AE2415ZAA1A NEK6181GK NEK2134GK	NF7CLX	105F1721	960	1587	2209	1727	2789	4237							195B0304
115/1/60	1/2	HS	ASE26C4E-CAA AJA2419ZX AKA9438ZX NEK6210GK	SC10CL	104L1503	776	1683	2562	1742	3111	5012	3532	5585					195B0147
115/1/60	1/2+	HS	AJA2425ZX NEK2150GK AFE17C4E-IAA	SC12CLX.2	104L1696 104L1603 195B0061	1419	2496	3525										195B0491
115/1/60	3/4	HS	AFE17C4E-CAA RST45C1E-IAA RST45C1E-CAA AE4470Z-AA NEK6213GK	SC12MLX	104L1606				2640	4391	6865	4962	7654					195B0510
115/1/60	3/4	HS	NT2168GKV	SC15CLX.2	104L1853 195B0237	1834	3118	4391										195B0701
115/1/60	3/4	HS	AKA9455ZX	SC15MLX.2	104L1807				3156	5120	7897							195B0447
115/1/60	3/4	HS	AKA9462ZX NT6222GKV	SC18MLX	104L2105			5025	3894	6296	9691	7082	10776					195B0702
115/1/60	3/4	HS	AJB2433ZX NT2180GKV	SC18CLX.2	104L2198	2198	3611	4873	3942	5929								195B0464
208-230/1/60	3/4	HS	RST61C1E-CAV RST64C1E-IAV RST64C1E-CAV AJB2433ZXD NT2180GKV	SC18CLX.2	104L2195		3741	5050	4084									195B0428
208-230/1/60	3/4	HS	AKA9455ZXD	MX18TGa	123B2541	1963	3415	4973	3777	6363	9825	7147	10817	11887				123B2541
208-230/1/60	3/4+	HS	AKA9462ZXD	MX21TGa	123B2714	2210	3769	5494	4204	7052	10900	7920	12018	13199				123B2714
208-230/1/60	1	HS	AWA2440ZXD	MX21FG	123B2131	2340	4101	5747	4262									123B2131
208-230/1/60	1 1/4	HS	AJB2444ZXD AWA2450ZXD	MS26FF	123B2157	2808	5281	7467	5373									123B2157
208-230/1/60	1 1/2	HS	AWA2460ZXD	MS34FF	123B2174	3331	6438	9545	7473	12563	18925	14034	25715	22583				123B2174

¹ Horsepower ratings are nominal. Danfoss recommends sizing compressors based on cooling capacity requirements.

² Capacity at ASHRAE conditions below. For other conditions and/or speeds, check Coolselector or contact Danfoss.

³ Code no. contains compressor and required electrical and non-electrical accessories.

Full range of models (refrigerant, capacity, and voltage codes) available. Check Coolselector or contact Danfoss.

Full range of models (refrigerant, capacity and voltage codes) available.

Check Coolselector or contact Danfoss.

Test conditions	ASHRAE (LBP)	ASHRAE (BBP)	ASHRAE (HBP)
Condensing temperature	110 °F	130 °F	130 °F
Ambient and suction gas temperature	90 °F	95 °F	95 °F
Liquid temperature	90 °F	115 °F	115 °F
Speed	3500	3500	

Scan the QR Code for a video of a light commercial replacement or visit <http://bit.ly/LightInstall>



Optyma™ - Condensing Units

Danfoss Optyma™ line of light commercial condensing units is available with sizes ranging from 1/8 hp to 13 1/2 hp for low and medium temperature applications for R-404A and R-134a. Its contractor-friendly design makes Optyma easy to install, quiet, and efficient.

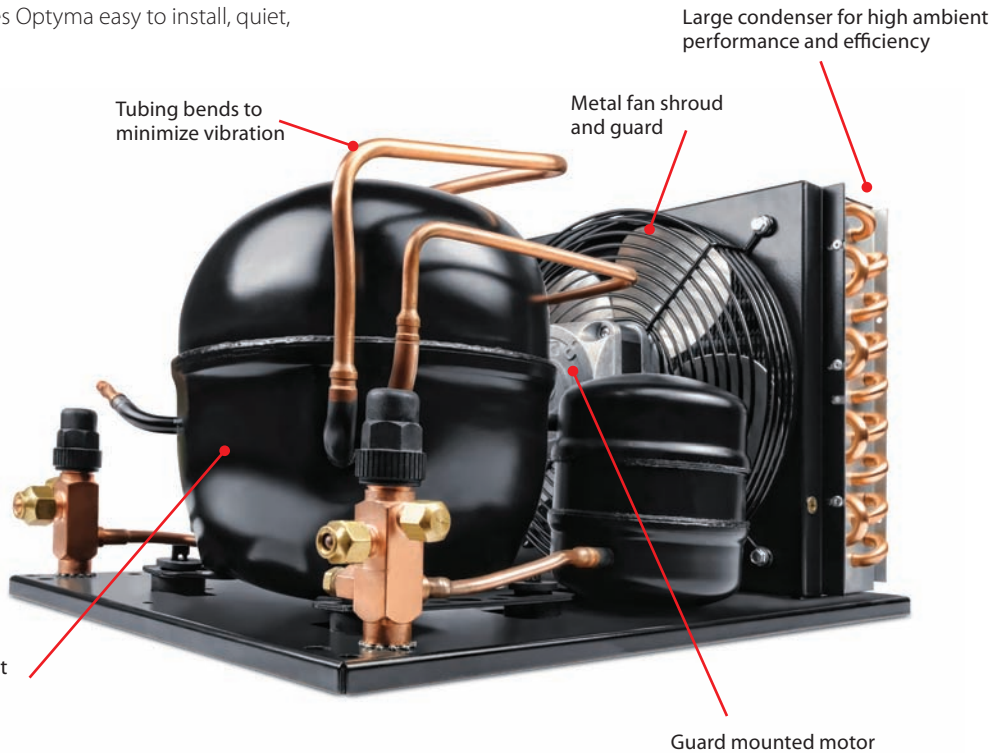

Nomenclature / Model No.

	Application	Design	Refrigerant	Condenser size	HP rating	Certification	Version	Electrical code
OP-	H	N	U	M	0300	U	WG000	Q
Application:	<ul style="list-style-type: none"> L: low H: medium / high U: universal low / medium / high 							Electrical code:
Design:	<ul style="list-style-type: none"> C: air cooled condenser, single fan, recip J: air cooled condenser, slim design, recip G: air cooled condenser, twin fan, recip N: air cooled condenser, slim design, scroll R: air cooled condenser, twin fan, scroll 							<ul style="list-style-type: none"> B: compressor & fan(s), 115V, 1ph, 60 Hz N: compressor & fan(s), 230V, 1ph, 60 Hz Q: compressor 208-230V, 3ph, 60 Hz fan(s) 230V, 1ph, 60 Hz R: compressor 460V, 3ph, 60 Hz fan(s) 460V, 1ph, 60 Hz
Refrigerant:	<ul style="list-style-type: none"> B: R-12 Replacement G: R-134a H: R-404A / R-507 M: R-22 Replacement Z: R-404A / R-134a / R-507 U: R-404A / R-134a / R-507/R-22 							Version:
Condenser size:	<ul style="list-style-type: none"> C: Sized to 110 °F ambient M: Microchannel Condenser size 115 °F ambient 							<ul style="list-style-type: none"> W: wholesale model A: power cord B: power cord, receiver C: electrical box, receiver D: electrical box, receiver, low pressure control E: electrical box, receiver, dual pressure control, fan cycling control, larger than 3 HP dual fan units use KPU fan cycling control F: WE and filter drier, sight glass, solenoid valve with coil G: electrical box, receiver, dual pressure control, fan speed controller, defrost timer, outdoor enclosure (MBP) H: electrical box, receiver, dual pressure control, fan speed controller, defrost timer, outdoor enclosure, suction accumulator (LBP)
HP rating:	<ul style="list-style-type: none"> HP rating in hundredths of HP, i.e.: 0033 = 1/3 HP, 0100 = 1 HP 							
Certification:	<ul style="list-style-type: none"> R: UL recognized U: UL listed 							

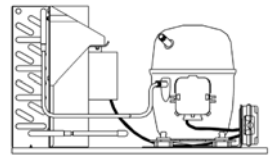

Technical data and ordering

Optyma™ - Condensing Units (1/3)

R-134a MBP			Ambient temperature (°F)	Capacity (Btu/h) ASHRAE ¹ at evaporating temperature (°F)									
Competitor Model Nos.	Danfoss Model No.	Danfoss Code No.		0	5	10	15	20	25	30	35	40	45
AEA3425 M2FH0020 M2FH0024	UCGC0020RWA000B	114N2017	90	1050	1200	1350	1500	1700	1850	2050	2250	2450	2700
			95	1000	1150	1300	1450	1600	1800	2000	2200	2400	2600
			100	950	1100	1250	1400	1550	1750	1900	2100	2300	2500
			110	900	1000	1150	1300	1450	1600	1800	1950	2150	2350
AEA4430 M2FH0026	UCGC0025RWB000B	114N2019	90	1250	1400	1600	1750	1950	2150	2400	2600	2850	3100
			95	1200	1350	1550	1700	1900	2100	2300	2500	2750	3000
			100	1150	1300	1450	1650	1800	2000	2200	2450	2650	2900
			110	1050	1200	1350	1550	1700	1900	2050	2250	2450	2700
AEA4440 AEA4448 M2FHA033	HCGC0033RWB000B	114N2022	90		2050	2300	2550	2850	3100	3450	3750	4100	4450
			95		1950	2200	2450	2750	3000	3300	3650	3950	4300
			100		1900	2100	2350	2600	2900	3200	3500	3800	4150
			110		1750	1950	2200	2450	2700	2950	3250	3550	3850
AKA4460 AKA7437 M2FH0049	UCGC0050RWC000B	114N2023	90	2350	2700	3050	3450	3800	4250	4700	5150	5650	6150
			95	2300	2600	2950	3300	3700	4100	4500	4950	5400	5900
			100	2200	2500	2800	3200	3550	3950	4350	4750	5200	5650
			110	2000	2300	2600	2900	3250	3600	4000	4400	4800	5200
	HCGC0055UWC000B	114N2026	90		2900	3300	3800	4300	4850	5450	6100	6700	7350
			95		2800	3200	3650	4150	4650	5250	5850	6450	7050
			100		2650	3050	3500	3950	4500	5050	5600	6150	6750
			110				3250	3700	4150	4700			
AJA4492 AJA7465 FTAHA074 FTAHA075 FTAHB074 FTAMA074 FTAMA075	HCGC0075UWC000B HCGC0075UWC000N	114N2027 114N2028	90		4350	4850	5550	6250	7150	8050	9100	10100	11200
			95		4100	4700	5350	6100	6950	7850	8800	9800	10850
			100		3900	4500	5150	5900	6750	7600	8550	9500	10450
			110				4850	5600	6400	7250	8100		
AJA4512 FTAHA100 FTAHA101	HCGC0100UWD000N	114N2029	90		6800	7450	8200	9050	9950	10950	12000	13050	14200
			95		6300	7000	7750	8550	9450	10400	11450	12450	13550
			100			6550	7300	8100	8950	9900	10900	11850	12900
			110				6500	7250	8100	9000			

¹ Ambient temperature = 90 °F, Return gas = 65 °F, Subcooling = 5 °F
Enclosure are available on page 56.

Optyma™ - Condensing Units (2/3)

R-404A MBP			Ambient temperature (°F)	Capacity (Btu/h) ASHRAE ¹ at evaporating temperature (°F)										
Competitor Model Nos.	Danfoss Model No.	Danfoss Code No.		0	5	10	15	20	25	30	35	40	45	
AEA9415 M4FH0022	UCHC0020RWA000B	114N2316	90	1000	1100	1250	1400	1500	1650	1800	2000	2150	2300	
			95	950	1050	1200	1300	1450	1600	1750	1900	2050	2200	
			100	900	1000	1100	1250	1350	1500	1650	1800			
			110	800	900	1000	1150	1250	1400	1500				
AEA9422 M4FH0025	UCHC0025RWB000B	114N2318	90	1650	1850	2050	2250	2450	2650	2900	3150	3400	3650	
			95	1600	1750	1950	2150	2350	2550	2800	3000	3250	3500	
			100	1500	1650	1850	2050	2250	2450	2650	2900	3100	3350	
			110	1350	1550	1700	1850	2050	2250					
AKA9429 M4FHA036	UCHC0033RWB000B	114N2321	90	2050	2250	2500	2750	3000	3250	3550	3850	4100	4450	
			95	1950	2150	2400	2600	2850	3100	3400	3650	3950	4250	
			100	1850	2050	2250	2500	2700	2950	3200	3500	3750	4050	
			110	1650	1850	2050								
AKA9440 M4FH0050	UCHC0050RWB000B UCHC0050UWC000N	114N2324 114N2325	90	2450	2750	3100	3400	3750	4100	4500	4900	5250	5700	
			95	2300	2600	2900	3200	3550	3850	4250	4600	4950	5350	
			100	2100	2400	2700	3000	3300	3600	3950	4300	4650	5000	
			110	1850	2100	2350	2600	2850	3150					
	HCHC0075UWC000B HCHC0075UWC000N	114N2330 114N2331	90	4400	4950	5500	6150	6800	7500	8250	9000	9800	10650	
			95	4150	4700	5250	5850	6500	7200	7900	8650	9400	10250	
			100	3900	4450	5000	5600	6200	6850	7550	8300	9050	9850	
			110	3500	4000	4550	5100	5700	6350	7000				
AJA7480 FJAMA100 FJAMA101 FJAMA106 FJAF100	HCHC0100UWD000N	114N2332	90		5900	6650	7450	8200	9000	9850	10650	11450	12300	
			95		5600	6350	7100	7800	8600	9350	10150	10950	11750	
			100			6000	6700	7400	8150	8900	9650	10400	11150	
			110				6100	6750	7400	8100	8800			
AWA7512 FJAMA125 FJAMA126 FJAMA150	HCZC0150UWF300Q HCZC0150UWF300R	114N6402 114N6403	90	6365	7471	8647	9891	11153	12524	13954	15440	16921	18503	
			95	5950	7009	8134	9323	10528	11835	13199	14614	16025	17531	
			100	5529	6542	7616	8750	9897	11141	12438	13783	15124	16554	
			110	4686	5600	6570	7591	8623	9740	10902	12108	13308	14588	
AWA7515 VJAF017H FJAMA200	HCZC0200UWF300N HCZC0200UWF300Q HCZC0200UWF300R	114N6404 114N6405 114N6406	90	8793	10070	11423	12848	14286	15836	17439	19089	20716	22434	
			95	8315	9529	10814	12164	13525	14990	16504	18061	19596	21217	
			100	7818	8969	10185	11461	12744	14125	15551	17017	18461	19986	
			110	6778	7801	8877	10003	11133	12346	13598	14883	16149	17497	
VJAF025H	HCZC0250UWF300N HCZC0250UWF300Q	114N6408 114N6409	90	11258	12870	14483	16253	18023	19974	21992	24108	26223	28532	
			95	10640	12182	13723	15412	17101	18963	20887	22903	24920	27134	
			100	10008	11478	12947	14554	16162	17933	19765	21689	23613	25720	
			110	8732	10057	11382	12827	14273	15867	17518	19256	20994		
AVA7523 FJAMA300 VJAF030H FJAMA325	HCZC0300UWF300N HCZC0300UWF300Q HCZC0300UWF300R	114N6420 114N6421 114N6422	90	15776	18105	20434	22974	25514	28281	31145	34130	37115	40306	
			95	14841	17062	19284	21704	24125	26775	29493	32347	35201	38255	
			100	13910	16023	18136	20438	22739	25260	27846	30557	33268	36201	
			110	12102	14000	15898	17964	20031	22301	24644				
VJAF035Z VJA035H	HGZC0400UWF300N HGZC0400UWF300Q HGZC0400UWF300R	114N6427 114N6428 114N6429	90	20074	23089	26103	29451	32798	36521	40377	44475	48573	53103	
			95	18817	21706	24596	27802	31008	34575	38286	42213	46140	50500	
			100	17545	20307	23068	26131	29194	32604	36155	39922	43689	47866	
			110	15020	17523	20026	22804	25583	28683	31918	35364	38809		
FJAMB400 VJAF040Z VJAF040H FJAMB500 VJAF050Z	HGZC0500UWF300N HGZC0500UWF300Q HGZC0500UWF300R	114N6435 114N6436 114N6437	90	24167	27679	31192	35047	38902	43145	47507	52087	56667	61623	
			95	22592	25935	29279	32946	36612	40649	44796	49160	53523	58258	
			100	21011	24184	27357	30833	34310	38139	42094	46221	50349	54852	
			110	17904	20734	23565	26663	29762	33179	36713	40415	44117		
FJAH100Z	HGZC1000UWF300Q HGZC1000UWF300R	114N6445 114N6446	90	50572	57395	64218	71795	79372	87743	96495	105668	115042		
			95	47531	54059	60587	67833	75078	83083	91458	100240	109214		
			100	44478	50707	56936	63848	70760	78397	86396	94789	103367		
			110	38467	44098	49729	55982	62236	69152	76414	84053	91921		
CJDM1000	HGZC1200UWF300R	114N6449	90	58238	65784	73330	81645	89960	99106	108643	118562	128799		
			95	54773	61980	69186	77124	85063	93843	102910	112381	122060		
			100	51292	58154	65015	72574	80133	88502	97144	103232	115500		
			110	44431	50602	56773	63580	70387	77948	85814	94021	102497		
FJAH120Z FJAM130Z	HGZC1350UWF300R	114N6452	90	62293	70102	77911	86496	95082	104476	114193	124446	134767		
			95	58588	66047	73506	81708	89910	98881	108213	117877	127858		
			100	54893	61999	69105	76922	84739	93288	102196	111448	120991		
			110	47666	54091	60516	67557	74599	82383	90417	98880			

¹Ambient temperature = 90 °F, Return gas = 65 °F, Subcooling = 5 °F
Enclosure are available on page 56.

Optyma™ - Condensing Units (3/3)

R-404A LBP			Ambient temperature (°F)	Capacity (Btu/h) ASHRAE ¹ at evaporating temperature (°F)										
Competitor Model Nos.	Danfoss Model No.	Danfoss Code No.		-40	-35	-30	-25	-20	-15	-10	-5	0	5	10
			90	350	400	450	550	600	700	800	900	1000	1100	1250
	UCHC0020RWA000B	114N2316	95	300	350	450	500	550	650	750	850	950	1050	1200
			100	300	350	400	450	550	600	700	800	900	1000	1100
			110	250	300	350	400	500	550	650	700	800	900	
AEA2410	UCHC0025RWB000B	114N2318	90	600	700	800	900	1050	1200	1350	1500	1650	1850	2050
			95	550	650	750	900	1000	1150	1250	1400	1600	1750	1950
			100	550	600	700	850	950	1050	1200	1350	1500	1650	1850
			110	450	550	650	750	850	950	1100	1250	1350	1550	1700
AEA2413 M4FL0033	UCHC0033RWB000B	114N2321	90	750	850	1000	1100	1300	1450	1650	1800	2050	2250	2500
			95	700	800	950	1050	1200	1400	1550	1750	1950	2150	2400
			100	650	750	850	1000	1150	1300	1450	1650	1850	2050	2250
			110	550	650	750	900	1000	1150	1350	1500			
AKA2422 M4FL0040	UCHC0050RWB000B UCHC0050UWC000N	114N2324 114N2325	90			1100	1300	1500	1700	1900	2150	2400	2700	2950
			95			1000	1200	1400	1600	1850	2050	2300	2550	2850
			100			900	1100	1300	1500	1750	1950	2200	2450	2700
			110			750	950	1150	1350	1550	1750	2000	2250	2500
	LCHC0050RWB000B	114N2389	90	1050	1250	1450	1700	1950	2200	2500	2800	3150	3450	3850
			95	950	1150	1350	1600	1850	2100	2400	2650	3000	3300	3650
			100	850	1050	1250	1500	1700	2000	2250	2500	2800	3150	3450
			110	700	900	1100	1300	1500	1750	2000	2300	2550	2850	3150
AJA2429 M4FL0051	LCHC0060UWC000B LCHC0060UWC000N	114N2335 114N2336	90	1350	1550	1850	2100	2400	2700	3050	3400	3800	4200	4600
			95	1250	1450	1700	1950	2250	2550	2900	3200	3600	3950	4350
			100	1150	1350	1600	1850	2100	2400	2700	3050	3400	3750	4100
			110	950	1150	1400	1600	1850	2150	2400	2700	3050	3350	
M4FL0067 FJAFA075	LCHC0075UWC000B LCHC0075UWC000N	114N2337 114N2338	90	1450	1800	2150	2550	2950	3400	3900	4400	4950	5550	6200
			95	1400	1750	2100	2450	2900	3350	3800	4300	4850	5450	6100
			100		1650	2000	2400	2800	3250	3750	4250	4800	5350	6000
			110						3100	3600	4100	4650	5200	
AWA2448 FJALA100 FJALA101 FJALA103 FJALA102	LCHC0100UWD000N	114N2339	90	1700	2250	2800	3400	4000	4650	5350	6000	6800	7550	8400
			95	1550	2100	2650	3200	3850	4500	5150	5850	6600	7400	8250
			100		1900	2500	3050	3650	4300	5000	5700	6450	7250	8100
			110						4000	4700	5400	6150	7000	
AWA2479 AWA2490 AVA2510 FJALB200 FJALA225	LCZC0200UWF300N LCZC0201UWF300Q LCZC0201UWF300R	114N6729 114N6730 114N6731	90	4953	5934	6985	8061	9238	10472	11757	13038	14404	15799	17217
			95	4585	5523	6525	7549	8666	9836	11052	12264	13553	14870	16204
			100	4236	5131	6085	7056	8114	9220	10369	11510	12724	13961	15212
			110	3586	4397	5254	6122	7063	8042	9054	10056	11117	12193	13277
AVA2512 AVA2515 VJAL025V FJALB301 VJAL035Z	LCZC0301UWF300Q	114N6734	90	6108	7619	9247	10912	12723	14600	16525	18408	20368	22317	24237
			95	5628	7070	8614	10189	11894	13658	15460	17219	19045	20855	22633
			100	5138	6512	7975	9460	11063	12714	14397	16033	17728	19402	21053
			110	4140	5375	6679	7989	9391	10823	12272	13670	15106	16526	17889
VJAL040Z VJAL050Z	LGZC0401UWF300N LGZC0401UWF300Q LGZC0401UWF300R	114N6737 114N6738 114N6739	90	8907	10928	13112	15368	17855	20487	23251	26032	29023	32109	35275
			95	8170	10112	12209	14369	16747	19258	21891	24537	27379	30307	33307
			100	7439	9304	11313	13378	15646	18037	20540	23050	25743	28514	31349
			110	6009	7726	9551	11422	13469	15617	17858	20098	22494	24950	27455
CJDL0600	LGZC0600UWF300Q LGZC0600UWF300R	114N6741 114N6742	90	14093	16971	20081	23290	26827	30564	34487	38430	42667	47035	51512
			95	12860	15622	18602	21669	25040	28594	32316	36051	40057	44180	48400
			100	11605	14266	17106	20030	23235	26607	30130	33659	37437	41319	45285
			110	9080	11509	14095	16720	19593	22601	25730	28850	32179	35585	39051
CPDK0600	LGZC0751UWF300Q LGZC0750UWF300R	114N6744 114N6745	90	19051	22596	26384	30245	34439	38796	43286	47709	52359	57039	61714
			95	17672	21054	24655	28312	32274	36379	40599	44747	49099	53470	57827
			100	16289	19508	22921	26375	30105	33960	37912	41788	45844	49908	53949
			110	13530	16417	19450	22497	25765	29120	32539	35872	39341	42795	46206

¹ Ambient temperature = 90 °F, Return gas = 65 °F, Subcooling = 5 °F
Enclosure are available on page 56.

Optyma™ Slim - Outdoor Condensing Units

The Danfoss Optyma™ Slim line of outdoor condensing units range in size from 1 to 10 hp for low and medium temperature applications for R-404A and R-134a. With a contractor-friendly, open design the

Optyma Slim is easy to install and service. Equipped with high quality Danfoss components, it provides reliable and efficient performance.

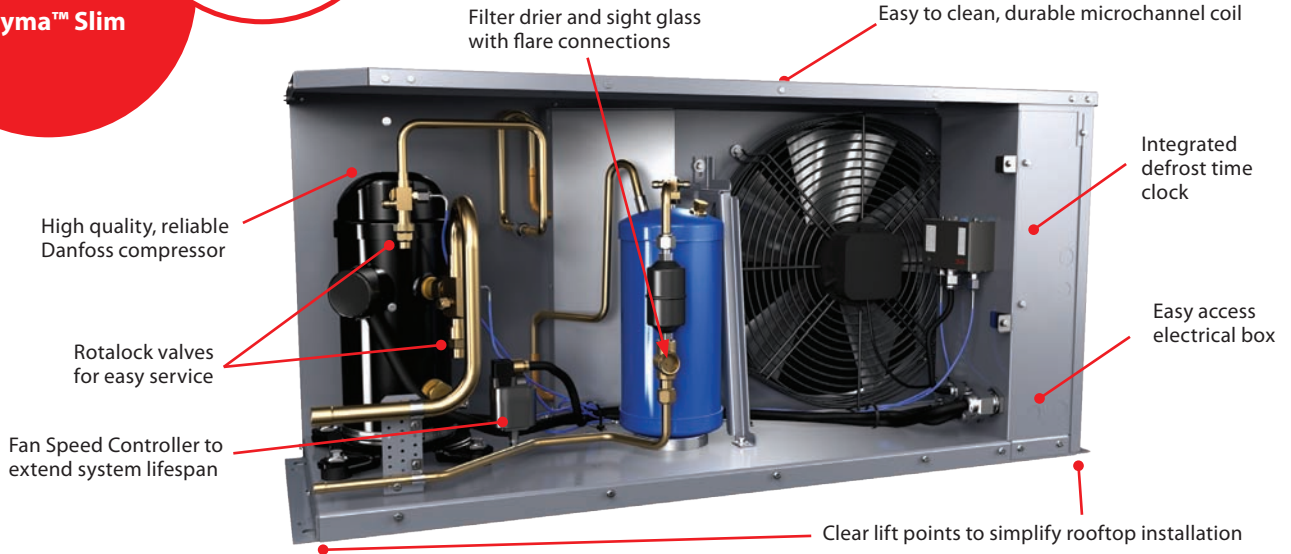

Nomenclature / Model No.

	Application	Design	Refrigerant	Condenser size	HP rating	Certification	Version	Electrical code
OP-	H	N	U	M	0300	U	WG000	Q
Application:	L: low H: medium / high U: universal low / medium / high							Electrical code: B: compressor & fan(s), 115V, 1ph, 60 Hz N: compressor & fan(s), 230V, 1ph, 60 Hz Q: compressor 208-230V, 3ph, 60 Hz fan(s) 230V, 1ph, 60 Hz R: compressor 460V, 3ph, 60 Hz fan(s) 460V, 1ph, 60 Hz
Design:	C: air cooled condenser, single fan, recip J: air cooled condenser, slim design, recip G: air cooled condenser, twin fan, recip N: air cooled condenser, slim design, scroll R: air cooled condenser, twin fan, scroll							
Refrigerant:	B: R-12 Replacement G: R-134a H: R-404A / R-507 M: R-22 Replacement Z: R-404A / R-134a / R-507 U: R-404A / R-134a / R-507/R-22							
Condenser size:	C: Sized to 110 °F ambient M: Microchannel Condenser size 115 °F ambient							
HP rating:	HP rating in hundredths of HP, i.e.: 0033 = 1/3 HP, 0100 = 1 HP							
Certification:	R: UL recognized U: UL listed							
							Version: W: wholesale model A: power cord B: power cord, receiver C: electrical box, receiver D: electrical box, receiver, low pressure control E: electrical box, receiver, dual pressure control, fan cycling control, larger than 3 HP dual fan units use KPU fan cycling control F: WE and filter drier, sight glass, solenoid valve with coil G: electrical box, receiver, dual pressure control, fan speed controller, defrost timer, outdoor enclosure (MBP) H: electrical box, receiver, dual pressure control, fan speed controller, defrost timer, outdoor enclosure, suction accumulator (LBP)	

Technical data and ordering

Optyma™ Slim - Outdoor Condensing Units (1/3)

R-134a MBP		Ambient temperature (°F)	Capacity (Btu/h)						
Danfoss Model No.	Danfoss Code No.		ASHRAE at evaporating temperature (°F)						
			10	15	20	25	30	35	40
HJZM0150UWG000N HJZM0150UWG000Q	114N3456 114N3457	90	5200	6050	6950	7950	9100	10350	11700
		95	4900	5700	6600	7600	8700	9900	11200
		100	4600	5400	6250	7200	8250	9450	10750
		110		4750	5550	6450	7450	8550	9750
		115		4400	5200	6050	7000	8100	9250
HNUM0200UWG000N HNUM0200UWG000Q	114N3460 114N3461	90	8700	9900	11200	12600	14100	15750	17450
		95	8450	9600	10900	12300	13750	15350	17000
		100	8200	9350	10600	11950	13400	14950	16550
		110		8750	9950	11200	12600	14050	15650
		115		8450	9600	10850	12200	13650	15150
HNUM0250UWG000N HNUM0250UWG000Q	114N3462 114N3463	90	11050	12600	14250	16000	17900	19900	22050
		95	10700	12200	13850	15550	17400	19400	21500
		100	10350	11850	13400	15100	16950	18850	20900
		110		11050	12550	14200	15900	17750	19700
		115		10650	12100	13700	15400	17150	19050
HNUM0300UWG000N HNUM0300UWG000Q	114N3464 114N3465	90	11700	13350	15100	17000	18950	21100	23300
		95	11300	12950	14700	16550	18500	20550	22700
		100	10950	12550	14250	16050	17950	20000	22100
		110		11700	13350	15100	16900	18800	20850
		115		11250	12850	14550	16350	18200	20150
HNUM0350UWG000N HNUM0350UWG000Q	114N3466 114N3467	90	14700	16700	18900	21250	23800	26550	29400
		95	14250	16200	18400	20700	23200	25850	28650
		100	13800	15750	17850	20100	22550	25150	27900
		110		14700	16700	18900	21200	23700	26300
		115		14150	16150	18250	20550	22950	25500
HNUM0400UWG000N HNUM0400UWG000Q	114N3468 114N3469	90	17550	19950	22550	25350	28350	31500	34900
		95	17000	19350	21900	24650	27600	30700	34000
		100	16450	18750	21250	23950	26800	29850	33100
		110		17500	19900	22500	25200	28100	31150
		115		16850	19200	21700	24350	27200	30150
HRUM0500UWG000N HRUM0500UWG000Q	114N3470 114N3471	90	20800	23600	26700	30050	33650	37500	41600
		95	20200	22950	25950	29250	32750	36550	40550
		100	19600	22250	25200	28400	31850	35550	39500
		110		20900	23700	26700	30000	33500	37250
		115		20200	22900	25850	29000	32450	36050
HRUM0600UWG000Q	114N3472	90	25500	28850	32550	36500	40700	45200	50000
		95	24650	27900	31500	35350	39450	43850	48500
		100	23750	26950	30400	34150	38200	42450	47000
		110		24900	28200	31750	35550	39550	43850
		115		23900	27050	30500	34150	38100	42250
HRUM0700UWG000Q	114N3473	90	27000	30500	34350	38450	42850	47500	52450
		95	26100	29500	33250	37250	41550	46100	50900
		100	25150	28500	32150	36000	40200	44600	49300
		110		26450	29850	33500	37450	41600	46050
		115		25400	28650	32200	36000	40100	44350
HRUM0750UWG000Q	114N3474	90	32750	37000	41600	46500	51750	57350	63300
		95	31800	35900	40350	45150	50300	55750	61550
		100	30800	34800	39150	43800	48750	54100	59750
		110		32550	36600	41000	45700	50700	56050
		115		31400	35350	39550	44100	48950	54150
HRUM1000UWG000Q	114N3476	90	41900	47100	52750	58900	65500	72500	79950
		95	40650	45700	51250	57250	63650	70500	77750
		100	39300	44250	49650	55500	61800	68450	75450
		110		41250	46400	51950	57900	64150	70800
		115		39700	44700	50100	55850	61950	68400

Optyma™ Slim - Outdoor Condensing Units (2/3)

R-404A MBP		Ambient temperature (°F)	Capacity (Btu/h) ASHRAE at evaporating temperature (°F)							
Danfoss Model No.	Danfoss Code No.		10	15	20	25	30	35	40	45
HJZM0150UWG000N HJZM0150UWG000Q	114N3456 114N3457	90	8900	10200	11550	13000	14450	16050	17650	19300
		95	8400	9650	10950	12300	13750	15200	16750	18350
		100	7900	9100	10350	11650	13000	14400	15850	17350
		110		7950	9050	10250	11450	12750	14050	15400
		115		7350	8400	9550	10700	11900	13150	14400
HNUM0200UWG000N HNUM0200UWG000Q	114N3460 114N3461	90	14550	16100	17750	19450	21300	23200	25250	27350
		95	13900	15400	16950	18600	20350	22200	24150	26200
		100	13250	14650	16150	17750	19400	21150	23000	24950
		110		13150	14500	15950	17450	19050	20750	22500
		115		12350	13650	15000	16450	17950	19550	21250
HNUM0250UWG000N HNUM0250UWG000Q	114N3462 114N3463	90	18900	20750	22700	24750	26900	29200	31550	34050
		95	18100	19850	21700	23700	25750	27950	30250	32650
		100	17250	18950	20750	22650	24600	26700	28900	31250
		110		17100	18750	20450	22300	24200	26200	28350
		115		16150	17700	19350	21100	22900	24850	26900
HNUM0300UWG000N HNUM0300UWG000Q	114N3464 114N3465	90	20000	21950	24000	26150	28400	30800	33250	35800
		95	19150	21000	23000	25050	27250	29500	31900	34350
		100	18250	20050	21950	23950	26050	28200	30500	32850
		110		18100	19850	21650	23550	25550	27650	29850
		115		17100	18750	20500	22300	24250	26250	28350
HNUM0350UWG000N HNUM0350UWG000Q	114N3466 114N3467	90	25550	28150	30850	33750	36750	39950	43250	46700
		95	24500	26950	29600	32350	35250	38300	41500	44800
		100	23450	25800	28300	30900	33700	36650	39700	42900
		110		23300	25600	28000	30550	33250	36050	39000
		115		22050	24250	26550	28950	31500	34200	37000
HNUM0400UWG000N HNUM0400UWG000Q	114N3468 114N3469	90	29500	32400	35500	38750	42150	45750	49450	53350
		95	28250	31050	34000	37100	40400	43800	47400	51150
		100	26950	29650	32450	35450	38600	41900	45300	48900
		110		26750	29300	32050	34900	37900	41050	44350
		115		25250	27700	30250	33000	35900	38900	42050
HRUM0500UWG000N HRUM0500UWG000Q	114N3470 114N3471	90	36100	39700	43500	47500	51700	56150	60850	65750
		95	34650	38100	41750	45600	49650	53900	58350	63050
		100	33200	36500	39950	43650	47500	51550	55850	60350
		110		33050	36250	39600	43100	46800	50700	54850
		115		31300	34300	37500	40850	44400	48100	52000
HRUM0600UWG000Q	114N3472	90	42700	46900	51350	56000	60900	66050	71400	76950
		95	40900	44950	49200	53650	58350	63250	68400	73750
		100	39100	42900	47000	51250	55750	60450	65400	70550
		110		38750	42450	46300	50400	54750	59250	63950
		115		36550	40100	43800	47700	51800	56100	60650
HRUM0700UWG000Q	114N3473	90	46100	50600	55350	60300	65500	70950	76550	82400
		95	44150	48450	52950	57750	62700	67900	73300	78850
		100	42100	46200	50550	55100	59850	64800	69950	75300
		110		41600	45500	49600	53950	58450	63150	68050
		115		39150	42900	46800	50900	55200	59650	64350
HRUM0750UWG000Q	114N3474	90	56650	62650	68950	75550	82450	89650	97200	105000
		95	53850	59600	65600	71900	78500	85350	92500	99950
		100	51000	56450	62200	68200	74450	80950	87750	94850
		110		49950	55100	60450	66050	71850	77950	84250
		115		46600	51400	56450	61700	67200	72900	78850
HRUM1000UWG000Q	114N3476	90	72050	78900	86200	93800	101900	110300	119000	128100
		95	68900	75400	82300	89550	97150	105100	113500	122100
		100	65650	71850	78350	85200	92400	99950	107800	116000
		110		64400	70200	76250	82600	89300	96300	103600
		115		60600	66000	71650	77600	83850	90400	97250

Optyma™ Slim - Outdoor Condensing Units (3/3)

R-404A LBP		Ambient temperature (°F)	Capacity (Btu/h) ASHRAE at evaporating temperature (°F)					
Danfoss Model No.	Danfoss Code No.		-25	-20	-15	-10	-5	0
LJZM0150UWH000N LJZM0150UWH000Q	114N3477 114N3478	90	5450	6400	7450	8500	9650	10850
		95		6000	6950	8000	9050	10200
		100		5600	6500	7450	8500	9550
		110				6450	7350	8300
		115					6750	7650
LJZM0200UWH000N LJZM0200UWH000Q	114N3479 114N3480	90	8400	9600	10900	12250	13650	15100
		95		9050	10250	11550	12850	14200
		100		8500	9650	10850	12100	13400
		110				9500	10650	11750
		115					9900	10950
LNZM0400UWH000Q	114N3481	90	13800	15500	17300	19300	21350	23550
		95		14900	16650	18550	20500	22600
		100		14300	16000	17750	19650	21600
		110				16150	17850	19600
		115					16900	18550
LNZM0500UWH000Q	114N3482	90	16600	18650	20900	23250	25850	28550
		95		17950	20050	22350	24800	27400
		100		17200	19250	21400	23700	26150
		110				19450	21500	23700
		115					20350	22450
LRZM0600UWH000Q	114N3483	90	20050	22550	25250	28200	31350	34750
		95		21700	24300	27100	30100	33350
		100		20850	23300	26000	28850	31900
		110				23650	26250	28950
		115					24900	27450
LRZM0800UWH000Q	114N3484	90	24650	27650	30950	34450	38250	42250
		95		26600	29750	33100	36650	40500
		100		25500	28500	31700	35100	38700
		110				28800	31800	35050
		115					30150	33150

MT/MTZ - Medium/High Temperature Reciprocating Compressors

Known for their legendary durability, Maneurop® reciprocating compressors from Danfoss cover a wide range of operating conditions. Maneurop MT and MTZ series hermetic reciprocating compressors are designed for high and medium temperature

applications. These compressors have a large internal free volume that protects against the risk of liquid hammering when liquid refrigerant enters the compressor.



Nomenclature / Model No.

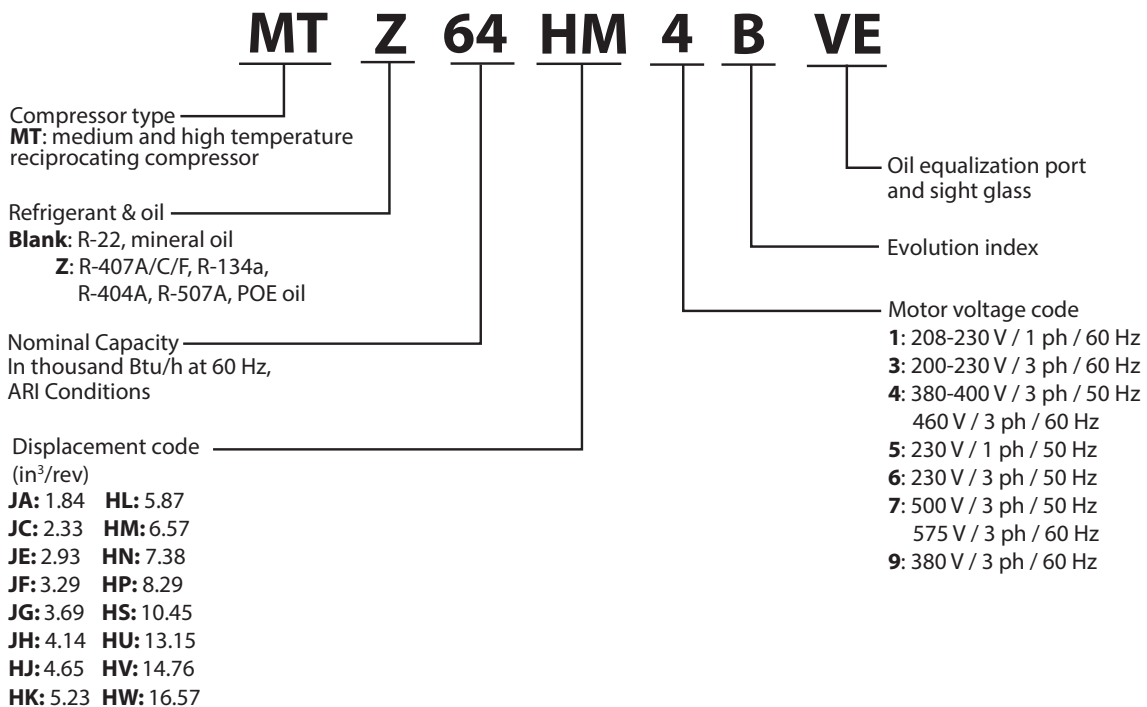

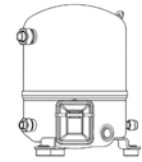

Technical data and ordering

MT/MTZ -Medium/High Temperature Reciprocating Compressors

Nominal capacity (Btu/h) ²			Connection type Rotolock (in.)	Connection with supplied sleeve (in. ODF)	No. of cylinders	Weight (lbs.)	208-230/1/60		200-230/3/60		460/3/60	
R-22 ³	R-134a ³	R-404A ⁴ R-507A ⁴					Danfoss Model No. ¹	Danfoss Code No.	Danfoss Model No. ¹	Danfoss Code No.	Danfoss Model No. ¹	Danfoss Code No.
15903			1 x 1	½ x ¾	1	46	MT18JA1*VE	MT18-1VI	MT18JA3*VE	MT18-3VI	MT18JA4*VE	MT18-4VI
21975			1 x 1 ⁽⁵⁾	½ x ¾ ⁽⁵⁾	1	46	MT22JC1*VE	MT22-1VI⁵	MT22JC3*VE	MT22-3VI	MT22JC4*VE	MT22-4VI
30231			1 x 1 ⁽⁵⁾	½ x ¾ ⁽⁵⁾	1	51	MT28JE1*VE	MT28-1VI⁵	MT28JE3*VE	MT28-3VI	MT28JE4*VE	MT28-4VI
33044			1 ¼ x 1	¾ x ½	1	53	MT32JF1*VE	MT32-1VI	MT32JF3*VE	MT32-3VI	MT32JF4*VE	MT32-4VI
37992			1 ¼ x 1	¾ x ½	1	55	MT36JG1*VE	MT36-1VI	MT36JG3*VE	MT36-3VI	MT36JG4*VE	MT36-4VI
42930			1 ¼ x 1	¾ x ½	1	57	MT40JH1*VE	MT40-1VI	MT40JH3*VE	MT40-3VI	MT40JH4*VE	MT40-4VI
43999			1 ¾ x 1 ¼	¾ x ¾	2	82	MT44HJ1*VE	MT44-1VI	MT44HJ3*VE	MT44-3VI	MT44HJ4*VE	MT44-4VI
50160			1 ¾ x 1 ¼	¾ x ¾	2	82	MT50HK1*VE	MT50-1VI	MT50HK3*VE	MT50-3VI	MT50HK4*VE	MT50-4VI
56420			1 ¾ x 1 ¼	¾ x ¾	2	86	MT56HL1*VE	MT56-1VI	MT56HL3*VE	MT56-3VI	MT56HL4*VE	MT56-4VI
64366			1 ¾ x 1 ¼	¾ x ¾	2	86	MT64HM1*VE	MT64-1VI	MT64HM3*VE	MT64-3VI	MT64HM4*VE	MT64-4VI
74561			1 ¾ x 1 ¼	¾ x ¾	2	88			MT72HN3*VE	MT72-3VI	MT72HN4*VE	MT72-4VI
84977			1 ¾ x 1 ¼	1 ⅛ x ¾	2	88			MT80HP3*VE	MT80-3VI	MT80HP4*VE	MT80-4VI
95898			1 ¾ x 1 ¼	1 ⅛ x ¾	4	132			MT100HS3*VE	MT100-3VI	MT100HS4*VE	MT100-4VI
124678			1 ¾ x 1 ¼	1 ⅛ x ¾	4	141			MT125HU3*VE	MT125-3VI	MT125HU4*VE	MT125-4VI
140697			1 ¾ x 1 ¼	1 ⅛ x ¾	4	148			MT144HV*VE	MT144-3VI	MT144HV4*VE	MT144-4VI
156820			1 ¾ x 1 ¼	1 ⅛ x ¾	4	152			MT160HW3*VE	MT160-3VI	MT160HW4*VE	MT160-4VI
11200	8980		1 x 1	½ x ¾	1	46	MTZ18JA1*VE	MTZ18-1VI	MTZ18JA3*VE	MTZ18-3VI	MTZ18JA4*VE	MTZ18-4VI
14849	12306		1 x 1 ⁽⁵⁾	½ x ¾ ⁽⁵⁾	1	46	MTZ22JC1*VE	MTZ22-1VI⁵	MTZ22JC3*VE	MTZ22-3VI	MTZ22JC4*VE	MTZ22-4VI
19276	15986		1 x 1 ⁽⁵⁾	½ x ¾ ⁽⁵⁾	1	51	MTZ28JE1*VE	MTZ28-1VI⁵	MTZ28JE3*VE	MTZ28-3VI	MTZ28JE4*VE	MTZ28-4VI
20949	17480		1 ¼ x 1	¾ x ½	1	53	MTZ32JF1*VE	MTZ32-1VI	MTZ32JF3*VE	MTZ32-3VI	MTZ32JF4*VE	MTZ32-4VI
24482	20189		1 ¼ x 1	¾ x ½	1	55	MTZ36JG1*VE	MTZ36-1VI	MTZ36JG3*VE	MTZ36-3VI	MTZ36JG4*VE	MTZ36-4VI
27864	23031		1 ¼ x 1	¾ x ½	1	57	MTZ40JH1*VE	MTZ40-1VI	MTZ40JH3*VE	MTZ40-3VI	MTZ40JH4*VE	MTZ40-4VI
30110	24323		1 ¾ x 1 ¼	¾ x ¾	2	82	MTZ44HJ1*VE	MTZ44-1VI	MTZ44HJ3*VE	MTZ44-3VI	MTZ44HJ4*VE	MTZ44-4VI
34538	28590		1 ¾ x 1 ¼	¾ x ¾	2	82	MTZ50HK1*VE	MTZ50-1VI	MTZ50HK3*VE	MTZ50-3VI	MTZ50HK4*VE	MTZ50-4VI
38881	32451		1 ¾ x 1 ¼	¾ x ¾	2	86					MTZ56HL4*VE	MTZ56-4VI
44404	36056		1 ¾ x 1 ¼	¾ x ¾	2	86	MTZ64HM1*VE	MTZ64-1VI	MTZ64HM3*VE	MTZ64-3VI	MTZ64HM4*VE	MTZ64-4VI
50000	40894		1 ¾ x 1 ¼	¾ x ¾	2	88			MTZ72HN3*VE	MTZ72-3VI	MTZ72HN4*VE	MTZ72-4VI
56336	46521		1 ¾ x 1 ¼	1 ⅛ x ¾	2	88			MTZ80HP3*VE	MTZ80-3VI	MTZ80HP4*VE	MTZ80-4VI
63963	52953		1 ¾ x 1 ¼	1 ⅛ x ¾	4	132			MTZ100HS*VE	MTZ100-3VI	MTZ100HS4*VE	MTZ100-4VI
78906	68297		1 ¾ x 1 ¼	1 ⅛ x ¾	4	141			MTZ125HU*VE	MTZ125-3VI	MTZ125HU4*VE	MTZ125-4VI
96936	80472		1 ¾ x 1 ¼	1 ⅛ x ¾	4	148			MTZ144HV*VE	MTZ144-3VI	MTZ144HV4*VE	MTZ144-4VI
107631	87421		1 ¾ x 1 ¼	1 ⅛ x ¾	4	152			MTZ160HW*VE	MTZ160-3VI	MTZ160HW4*VE	MTZ160-4VI

¹ These compressor models have threaded sight glass and ¾ in. flare oil equalization line.

² To determine the nominal capacity for R-407A/C/F, check Coolselector or visit our Online Datasheet Generator at www.danfoss.com/odsg.

³ Evaporator temperature = 45 °F, condensing temperature = 130 °F, superheat = 20 °F, subcooling = 15 °F

⁴ Evaporator temperature = 20 °F, condensing temperature = 120 °F, superheat = 20 °F, subcooling = 0 °F

⁵ Actual connection for MT and MTZ 22-28 (208-230/1/60) is rotolock 1 ¼ in. x 1 in. and connection with supplied sleeve is ¾ in. x ½ in. ODF. Capacitor values and relays for 1 phase compressors are available on page 55.

Spare parts and accessories are available on pages 57-58.

NTZ - Low Temperature Reciprocating Compressors

The Maneurop® NTZ series of reciprocating compressors from Danfoss Commercial Compressors are designed for low evaporating temperature applications with refrigerants R-404A and R-507A. The NTZ series is optimized at -30 °F with an extended evaporating

temperature range from -50 °F to +15 °F. NTZ compressors have a large internal free volume that protects against the risk of liquid hammering when liquid refrigerant enters the compressor.

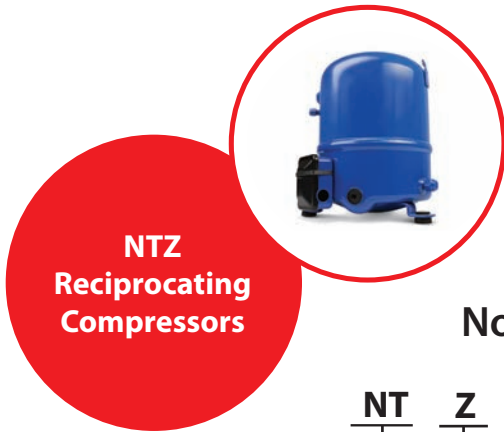

Nomenclature / Model No.

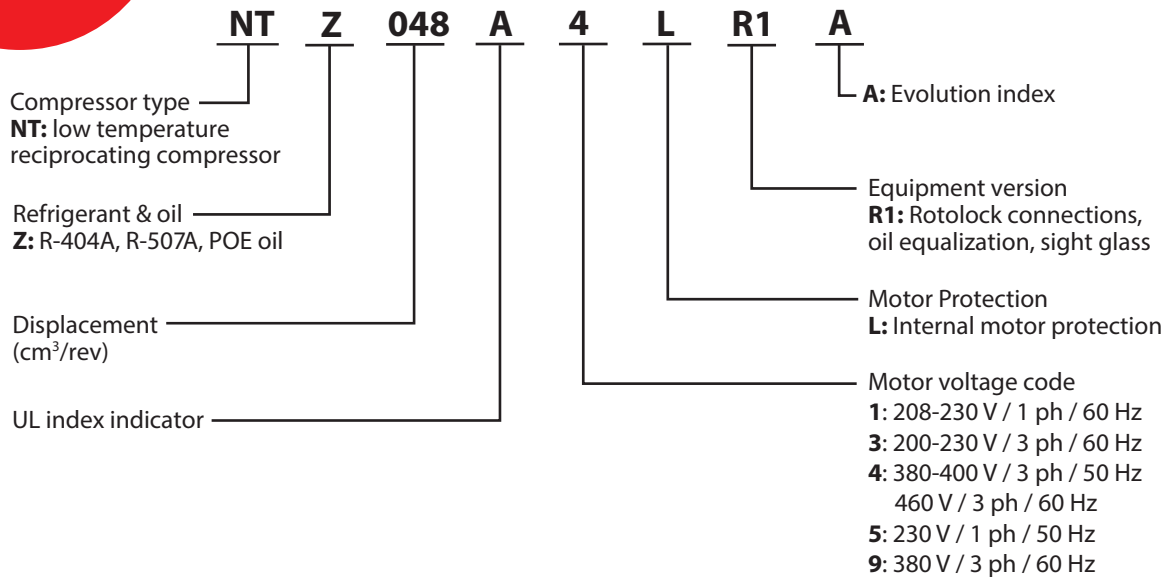

Technical data and ordering

NTZ - Low Temperature Reciprocating Compressors

Connection type Rotolock (in.)	Connection with supplied sleeve (in. ODF)	No. of cylinders	Weight (lbs.)	208-230/1/60			200-230/3/60			460/3/60		
				Danfoss Model No.	Nominal capacity ¹ (Btu/h)	Danfoss Code No. ²	Danfoss Model No.	Nominal capacity ¹ (Btu/h)	Danfoss Code No. ²	Danfoss Model No.	Nominal capacity ¹ (Btu/h)	Danfoss Code No. ²
1 ¼ × 1	¾ × ½	1	46	NTZ048A1LR1*	4547	120F0072	NTZ048A3LR1*	4490	120F0026	NTZ048A4LR1*	4490	120F0001
1 ¼ × 1	¾ × ½	1	51	NTZ068A1LR1*	6649	120F0073	NTZ068A3LR1*	7518	120F0027	NTZ068A4LR1*	7518	120F0002
1 ¾ × 1 ¼	7/8 × ¾	2	77	NTZ096A1LR1*	9155	120F0074	NTZ096A3LR1*	9110	120F0028	NTZ096A4LR1*	9110	120F0003
1 ¾ × 1 ¼	7/8 × ¾	2	77	NTZ108A1LR1*	10805	120F0075	NTZ108A3LR1*	10536	120F0029	NTZ108A4LR1*	10536	120F0004
1 ¾ × 1 ¼	1 ½ × ¾	2	77	NTZ136A1LR1*	13901	120F0076	NTZ136A3LR1*	13901	120F0030	NTZ136A4LR1*	13901	120F0005
1 ¾ × 1 ¼	1 ½ × ¾	4	137				NTZ215A3LR1*	21461	120F0031	NTZ215A4LR1*	21461	120F0006
1 ¾ × 1 ¼	1 ½ × ¾	4	141				NTZ271A3LR1*	29788	120F0032	NTZ271A4LR1*	29788	120F0007

¹ Evaporating temperature = -25 °F, condensing temperature = 105 °F, superheat = 20 °F, subcooling = 0 °F.

² Single compressor, threaded sight glass, 3/8 in. oil equalization connection.

Capacitor values and relays for 1 phase compressors are available on page 55.

Spare parts and accessories are available on pages 57-58.

H Series - Residential and Light Commercial Scroll Compressors

Danfoss Residential and Light Commercial Air Conditioning Scroll Compressors install quickly and easily and feature a design that minimizes internal parts, decreasing the overall weight and significantly reducing noise during operation. With a bolt pattern and

liquid and suction line connections that line up with those of other major scroll compressor manufacturers, Danfoss scroll compressors can be used to replace compressors made by nearly any company.



Models with spade terminals include wire harness



H R M 025 U 1 L P 6 A

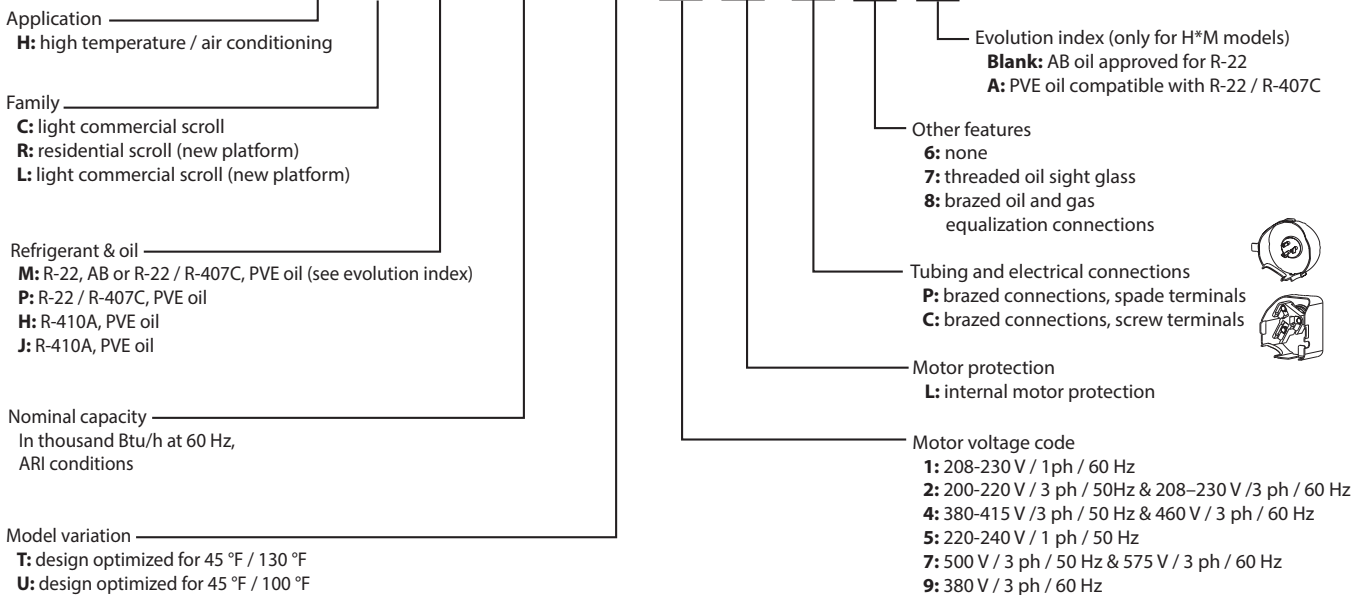

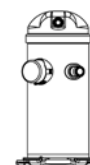

Technical data and ordering

H Series - Residential and Light Commercial Scroll Compressors (R-22/R-407C)

Refrigerant	Motor Voltage	Tons (approx.)	Competitor Model No.	Solder ODF connection (in.)	Weight (lbs.)	OLD Danfoss Model	NEW Danfoss Model		
						Danfoss Model No.	Danfoss Model No.	Danfoss Code No.	
R-22	R-407C	2	ZR25K-PFV	$\frac{3}{4} \times \frac{1}{2}$	73	HRM025T1LP6	HRP025T1LP6	120U3307 ¹	
		2 ½	ZR28K*-PFV ZR32K*-PFV	$\frac{3}{4} \times \frac{1}{2}$	75	HRM032U1LP6	HRM032U1LP6A	120U3308 ¹	
		3	ZR34K*-PFV ZR36K*-PFV	$\frac{3}{4} \times \frac{1}{2}$	75	HRM038U1LP6	HRM038U1LP6A	120U3309 ¹	
		3 ½	ZR40K*-PFV ZR42K*-PFV	$\frac{3}{4} \times \frac{1}{2}$	75	HRM040U1LP6 HRM042U1LP6	HRP042T1LP6	120U3310 ¹	
		4	ZR47K*-PFV	$\frac{7}{8} \times \frac{1}{2}$	77	HRM047U1LP6	HRM047U1LP6A	120U3311 ¹	
		4 ½	ZR54K*-TF5	$\frac{7}{8} \times \frac{1}{2}$	97	HRM054U1LP6	HRM054U1LP6A	120U3312 ¹	
		5	ZR57K*-PFV ZR61K*-PFV	$\frac{7}{8} \times \frac{1}{2}$	97	HRM060U1LP6	HRP060T1LP6	120U3313 ¹	
		2: 200–220V/3/50Hz & 208–230V/3/60Hz	3 ½	ZR42K*-TF5	$\frac{3}{4} \times \frac{1}{2}$	75	HRM042U2LP6	HRM042U2LP6A	120U3314 ¹
			4	ZR47K*-TF5	$\frac{7}{8} \times \frac{1}{2}$	71	HRM047U2LP6	HRP047T2LP6	120U3315 ¹
			4 ½	ZR54K*-TF5	$\frac{7}{8} \times \frac{1}{2}$	93	HRM054U2LP6	HRM054U2LP6A	120U3316 ¹
			5	ZR57K*-TF5 ZR61K*-TF5	$\frac{7}{8} \times \frac{1}{2}$	93	HRM060U2LP6	HRP060T2LP6	120U3317 ¹
			5 ½		$\frac{7}{8} \times \frac{1}{2}$	85		HLM068T2LC6A	120U3276
			6	ZR72K*-TF5	$\frac{7}{8} \times \frac{1}{2}$	95	HLM072T2LC6 HLM075T2LC6	HLM075T2LC6	120U3098
			7	ZR81KC-TF5	$\frac{7}{8} \times \frac{3}{4}$	91	HLM081T2LC6	HLP081T2LC6	120U1916
			8	ZR94KC-TF5	$1 \frac{1}{8} \times \frac{7}{8}$	108	HCM094T2LC6	HCP094T2LC6	120U0906
		4: 380–415V/3/50Hz & 460V/3/60Hz	10	ZR125KC-TF5 ZR12M3*-TWC	$1 \frac{1}{8} \times \frac{7}{8}$	106	HCM120T2LC6	HCP120T2LC6	120U0766
			4	ZR47K*-TFD	$\frac{7}{8} \times \frac{1}{2}$	82	HRM047U4LP6	HRP047T4LP6	120U3318 ²
			4 ½	ZR54K*-TFD	$\frac{7}{8} \times \frac{1}{2}$	89	HRM054U4LP6	HRP054T4LP6	120U3319 ²
			5	ZR57K*-TFD ZR61K*-TFD	$\frac{7}{8} \times \frac{1}{2}$	88	HRM058U4LP6 HRM060U4LP6	HRP060T4LP6	120U3320 ²
			5 ½		$\frac{7}{8} \times \frac{1}{2}$	86		HLP068T4LC6	120U2014
			6	ZR72K*-TFD	$\frac{7}{8} \times \frac{1}{2}$	58	HLM072T4LC6 HLM075T4LC6	HLP075T4LC6	120U1766
			7	ZR81KC-TFD	$\frac{7}{8} \times \frac{3}{4}$	94	HLM078T4LC6 HLM081T4LC6	HLP081T4LC6	120U1781
			8	ZR94KC-TFD	$1 \frac{1}{8} \times \frac{7}{8}$	101	HCM094T4LC6	HCP094T4LC6	120U0601
			9	ZR108KC-TFD ZR11M3-TWD	$1 \frac{1}{8} \times \frac{7}{8}$	108	HCM109T4LC6	HCP109T4LC6	120U0376
			10	ZR12M3-TWD	$1 \frac{1}{8} \times \frac{7}{8}$	109	HCM120T4LC6	HCP120T4LC6	120U0401

¹ Compressor comes kitted with wire harness (Danfoss Code No. 120Z5056)

² Compressor comes kitted with wire harness (Danfoss Code No. 120Z5057)

Additional models may be available upon request.

Full range of models (refrigerant, tons and voltage codes) available. Check Coolselector or visit our Online Datasheet Generator at www.danfoss.com/odsg.

Capacitor values and relays for 1 phase compressors are available on pages 55.

Spare parts and accessories are available on pages 58.

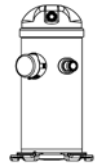

Technical data and ordering

H Series - Residential and Light Commercial Scroll Compressors (R-410A)

Refrigerant	Motor Voltage	Tons (approx.)	Competitor Model No.	Solder ODF connection (in.)	Weight (lbs.)	OLD Danfoss Model	NEW Danfoss Model		
						Danfoss Model No.	Danfoss Model No.	Danfoss Code No.	
R-410A	1: 200–230V/1/60Hz	2 ½	ZP29K*E-PFV ZP31K*E-PFV ZP32K*E-PFV	¾ × ½	70	HRH032U1LP6	HRH032U1LP6	120U3321 ¹	
		3		¾ × ½	94	HRH038U1LP6	HRH036U1LP6	120U3322 ¹	
		3 ¼		¾ × ½	73	HRH040U1LP6	HRH040U1LP6	120U3323 ¹	
		3 ¾		¾ × ½	99		HRH044U1LP6	120U3324 ¹	
		4		¾ × ½	79	HRH048U1LP6	HRH048U1LP6	120U3325 ¹	
		4 ½		¾ × ½	82		HRH051U1LP6	120U3326 ¹	
			5		¾ × ½	90	HLH061T1LP6	HLH061T1LP6	120U3327 ¹
	2: 200–220/3/50Hz & 208–230V/3/60Hz	3 ¼	ZP36K*E-TF5 ZP38K*E-TF5 ZP41K*E-TF5	¾ × ½	77	HRH040U2LP6	HRH040U2LP6	120U3328 ¹	
		3 ¾	ZP44K*E-TF5	¾ × ½	89		HRH044U2LP6	120U3329 ¹	
		4	ZP51K*E-TF5	¾ × ½	85		HRH051U2LP6	120U3330 ¹	
		5		¾ × ½	90	HLH61T2LC6	HLH06T2LC6	120U2062	
		5 ½	ZP67KCE-TF5	¾ × ½	89	HLH068T2LC6	HLH068T2LC6	120U1481	
		6	ZP72KCE-TF5	¾ × ½	96	HLJ072T2LC6	HLJ072T2LC6	120U1486	
		7	ZP83KCE-TF5	¾ × ½	96	HLJ083T2LC6	HLJ083T2LC6	120U1491	
		7 ½	ZP90KCE-TF5	1 ⅛ × ⅞	102	HCJ090T2LC6	HCJ090T2LC6	120U2307	
		8 ½	ZP103KCE-TF5	1 ⅛ × ⅞	104	HCJ105T2LC6	HCJ105T2LC6	120U2327	
		10	ZP120KCE-TF5	1 ⅛ × ⅞	106	HCJ120T2LC6	HCJ120T2LC6	120U2347	
	4: 380–415V/3/50Hz & 460V/3/60Hz	3 ¼	ZP36K*E-TFD ZP38K*E-TFD ZP41K*E-TFD	¾ × ½	77	HRH036U4LP6 HRH038U4LP6 HRH040U4LP6	HRH040U4LP6	120U3331 ²	
		3 ¾	ZP44K*E-TFD	¾ × ½	77		HRH044U4LP6	120U3332 ²	
		4	ZP51K*E-TFD	¾ × ½	87		HRH051U4LP6	120U3333 ²	
		5	ZP61KCE-TFD	¾ × ½	96	HLH061T4LC6	HLH061T4LC6	120U2052	
		5 ½	ZP67KCE-TFD	¾ × ½	96	HLH068T4LC6	HLH068T4LC6	120U1391	
		6	ZP72KCE-TFD	¾ × ½	97	HLJ072T4LC6	HLJ072T4LC6	120U1396	
		7	ZP83KCE-TFD	¾ × ½	93	HLJ083T4LC6	HLJ083T4LC6	120U1401	
		7 ½	ZP90K*E-TFD	1 ⅛ × ⅞	109	HCJ090T4LC6	HCJ090T4LC6	120U2302	
		8 ½	ZP104KCE-TFD	1 ⅛ × ⅞	109	HCJ105T4LC6	HCJ105T4LC6	120U2322	
10		ZP120K*E-TFD	1 ⅛ × ⅞	164	HCJ120T4LC6	HCJ120T4LC6	120U2342		

¹ Compressor comes kitted with wire harness (Danfoss Code No. 120Z5056)

² Compressor comes kitted with wire harness (Danfoss Code No. 120Z5057)

Additional models may be available upon request.

Full range of models (refrigerant, tons and voltage codes) available. Check Coolselector or visit our Online Datasheet Generator at www.danfoss.com/odsg.

Capacitor values and relays for 1 phase compressors are available on page 55.

Spare parts and accessories are available on page 58.

S Series - Light Commercial and Commercial Scroll Compressors

Danfoss Performer® Universal Scroll Compressors are designed to serve as quick, easy replacements for most commercial air conditioning scroll compressors. These compressors come with a bolt

pattern, suction and discharge lines, and performance characteristics that match up directly with some competitors' products.



Nomenclature / Model No.

SM 115 S 4 Q C
SH 090 A 4 AL C

Refrigerant & oil

SM: R-22, mineral oil
SY: R-22, R-407C (SY185-300), POE oil
SZ: R-407C, R-134a, R-404A / R-507A (SZ084-185), POE oil
SH: R-410A, POE oil

Nominal Capacity

In thousand Btu/h at 60 Hz, ARI Conditions

UL index

Motor voltage code

3: 200-230 V / 3 ph / 60 Hz
4: 380-400 V / 3 ph / 50 Hz & 460 V / 3 ph / 60 Hz
6: 230 V / 3 ph / 50 Hz
7: 500 V / 3 ph / 50 Hz & 575 V / 3 ph / 60 Hz
9: 380 V / 3 ph / 60 Hz

Evolution index

Version (for SM, SY, SZ)	Motor protection module	Connection	Module voltage	Applies to
V	Internal overload protector	brazed		084, 090, 100, 110, 120, 148, 161
A		brazed		112, 124, 147
C	Internal thermostat	brazed		115, 125, 160, 175, 185
Q		brazed		
R		rotolock		
P	Electronic protection module	brazed	24V AC	
X		brazed	230V	
S		rotolock	24V AC	
Y		rotolock	230V	
CA		brazed	24V AC	240, 300, 380
CB		brazed	115/230V	
PA		rotolock	24V AC	
PB	rotolock	115/230V		
AC	contact OEM			

Version (for SH)	Motor protection module	Connection	Module voltage	Applies to
AL	Internal overload protector	brazed		090, 105, 120, 140, 161, 175, 184
AA	Electronic protection module	brazed	24V AC	240, 295, 300, 380, 485
AB		brazed	115/230V	
AB		brazed	230V	180
AC	contact OEM			



Scan the QR Code for a video of a scroll compressor replacement or visit <http://bit.ly/ScrollInstall>

Technical data and ordering

S Series - Scroll Compressors (1/2)



Nominal tonnage	Voltage/Phase/Frequency	Competitor Part Nos. ¹		R-22		R-407C		Net weight (lbs.)	Connection size/type (suction x discharge)	Solder sleeve adapter set for Rotolock connectors
				Danfoss Model No.	Danfoss Code No. ²	Danfoss Model No.	Danfoss Code No. ²			
7 ½	200-230/3/60		ZR94KC-TF5	SM090S3VC	SM090-3VI	SZ090S3VC	SZ090-3VI	143	1 ¾ x ¾ Braze	7765005
	460/3/60 400/3/50		ZR94KC-TFD	SM090S4VC	SM090-4VI	SZ090S4VC	SZ090-4VI			
9 ½	200-230/3/60	CSHA-093R-0*00 or 0A	ZR108KC-TF5 ZR11M3-TWC	SM115S3QC	SM115-3QAI	SZ115S3QC	SZ115-3QAI	172	1 ¾ x 7/8 Braze	120Z0405
	460/3/60 400/3/50	CSHA-093K-0*00 or 0A	ZR108KC-TFD ZR11M3-TWD	SM115S4QC	SM115-4QAI	SZ115S4QC	SZ115-4QAI			
10	200-230/3/60	CSHA-100R-0*00 or 0A	ZR125KC-TF5 ZR12M3-TWC	SM125S3QC	SM125-3QAI	SZ125S3QC	SZ125-3QAI			
	460/3/60 400/3/50	CSHA-100K-0*00 or 0A	ZR125KC-TFD ZR12M3-TWD	SM125S4QC	SM125-4QAI	SZ125S4QC	SZ125-4QAI			
12 ½	200-230/3/60	CSHA-125R-0*00 or 0A	ZR16M3-TWC	SM160T3CC	SM160-3CBI	SZ160T3CC	SZ160-3CBI	198		
	460/3/60 400/3/50	CSHA-125K-0*00 or 0A	ZR16M3-TWD	SM160T4CC	SM160-4CBI	SZ160T4CC	SZ160-4CBI			
14	200-230/3/60	CSHA-140R-0*00 or 0A		SM175S3QC	SM175-3QAI	SZ175S3QC	SZ175-3QAI	220	1 ¾ x 1 ¾ Braze	7765028
	460/3/60 400/3/50	CSHA-140K-0*00 or 0A		SM175S4QC	SM175-4QAI	SZ175S4QC	SZ175-4QAI			
15	200-230/3/60	CSHA-150R-0*00 or 0A	ZR190KC-TW5 ZR19M3-TWC	SM185S3QC	SM185-3QAI	SZ185S3QC	SZ185-3QAI			
	460/3/60 400/3/50	CSHA-150K-0*00 or 0A	ZR190KC-TWD ZR19M3-TWD	SM185S4QC	SM185-4QAI	SZ185S4QC	SZ185-4QAI			

¹ Competitor Model Nos. beginning "ZR" may have different footprint, suction, discharge or height compared to Danfoss Model No.

² Code Nos. ending "QAI" include threaded sight glass, 3/8 in. ODF oil equalization connection, brazed suction and discharge connections and mounting bracket.

Code Nos. ending "VI" and "CBI" have threaded sight glass, 3/8 in. flare SAE oil equalization connection and brazed suction and discharge connections. Use compressor beginning with SM when system will use R-22; Use compressor beginning with SZ when retrofitting system to R-407C. For additional information, see Danfoss Literature No. DKRCC.PE.000.H1.02 (<http://bit.ly/RefrigerantRetrofits>)

Full range of models (refrigerant, tons and voltage codes) available. Check Coolselector or visit our Online Datasheet Generator at www.danfoss.com/odsg.

Spare parts and accessories are available on pages 58–59.

S Series - Scroll Compressors (2/2)

Refrigerant	Nominal tonnage	Voltage/Phase/Frequency	Competitor Part Numbers ¹	Danfoss Model No.	Danfoss Part No.	Motor module voltage	Net weight (lbs.)	Connection size/type (suction x discharge)	Solder sleeve adapter set for Rotolock connectors	
R-410A	7 1/2	200-230/3/60	CSHD089J0A0M CSHD092J0A0M	ZP90KCE-TF5	SH090A3AL*	120H0001	128	1 1/8 x 7/8 Braze	120Z0405	
		460/3/60	CSHD089K0A0M CSHD092K0A0M	ZP90KCE-TFD	SH090A4AL*	120H0003				
	9	200-230/3/60	CSHD105J0A0M CSHD110J0A0M	ZP103KCE-TF5	SH105A3AL*	120H0209	141			
		460/3/60	CSHD105K0A0M CSHD110K0A0M	ZP103KCE-TFD	SH105A4AL*	120H0211				
	10	200-230/3/60	CSHD120J0A0M CSHD125J0A0M	ZP120KCE-TF5	SH120A3AL*	120H0011	141			
		460/3/60	CSHD120K0A0M CSHD125K0A0M	ZP120KCE-TFD	SH120A4AL*	120H0013				
	12	200-230/3/60	CSHD136J0A0M CSHD142J0A0M	ZP137KCE-TF5	SH140A3AL*	120H0199	148			
		460/3/60	CSHD136K0A0M CSHD142K0A0M	ZP137KCE-TFD	SH140A4AL*	120H0201				
	13	200-230/3/60	CSHD155J0A0M CSHD161J0A0M	ZP154KCE-TF5	SH161A3AL*	120H0021	152			
		460/3/60	CSHD155K0A0M CSHD161K0A0M	ZP154KCE-TFD	SH161A4AL*	120H0023				
	15	200-230/3/60	CSHD175J0A0M CSHD183J0A0M	ZP182KCE-TW5	SH184A3AL*	120H0359	158			
		460/3/60	CSHD175K0A0M CSHD183K0A0M	ZP182KCE-TWD	SH184A4AL*	120H0361				
	20	200-230/3/60	CSHN240J0AHM CSHN250J0AHM	ZP235KCE-TW5 ²	SH240A3AA* SH240A3AB*	120H0289 120H0297	24VAC 115/230VAC			238
		460/3/60	CSHN240J0AKM CSHN250J0AKM	ZP235KCE-TWD ²	SH240A4AA* SH240A4AB*	120H0291 120H0299	24VAC 115/230VAC			
	25	200-230/3/60	CSHN315J0AHM CSHN315J0AKM	ZP295KCE-TW5 ²	SH295A3AA* SH295A3AB*	120H0851 120H0853	24VAC 115/230VAC			337
		460/3/60	CSHN315K0AHM CSHN315K0AKM	ZP295KCE-TWD ²	SH295A4AA* SH295A4AB*	120H0825 120H0827	24VAC 115/230VAC			
	30	200-230/3/60	CSHN374J0AHM CSHN374J0AKM	ZP385KCE-TW5 ²	SH380A3AA* SH380A3AB*	120H0151 120H0152	24VAC 115/230VAC			362
		460/3/60	CSHN374K0AHM CSHN374K0AKM	ZP385KCE-TWD ²	SH380A4AA* SH380A4AB*	120H0253 120H0255	24VAC 115/230VAC			

¹Competitor Model Nos. beginning "ZP" may have different footprint, suction, discharge or height compared to Danfoss Model No.

²Control voltage of external motor protection module must be checked before crossing to Danfoss Model No with 24V ac or 115/230V motor protection module. Full range of models (refrigerant, tons and voltage codes) available. Check Coolselector or visit our Online Datasheet Generator at www.danfoss.com/odsg. Spare parts and accessories are available on pages 58–59.

Capacitors and Relays

Danfoss Models	Start capacitor (μF)	Start capacitor voltage (V)	Run capacitor (μF)	Run capacitor voltage (V)	Start relay Model No.	Start relay Code No.
MT/MTZ18 JA-1	100	330	25	440	RVA 6AMKL (Electrica)	8173022
MT/MTZ22 JC-1	100	330	45	440		
MT/MTZ28 JE-1	135	330	50	440		
MT/MTZ32 JF-1	100	330	45	440		
MT/MTZ36 JG-1	100	330	45	440		
MT/MTZ40 JH-1	100	330	55	440		
MT/MTZ44 HJ-1	135	330	45	440		
MT/MTZ50 HK-1	135	330	45	440		
MT/MTZ56 HL-1	200	330	55	440		
MT/MTZ64 HM-1	235	330	55	440		
NTZ048A1LR1A	100	330	25	440	RVA 6AMKL (Electrica)	8173022
NTZ068A1LR1A	135	330	50	440		
NTZ096A1LR1A	135	330	45	440		
NTZ108A1LR1A	135	330	45	440		
NTZ136A1LR1A	135	330	45	440		
HRM025	145–175	330	45	370	RVA 2ACKO (Electrica)	120Z0396
HRM032-034	145–175	250	45	370	RVA 2ACKO (Electrica)	120Z0396
HRM038	88–108	330	55	370	RVA 2ABKO (Electrica)	120Z0397
HRM040-045	88–108	330	60	370	RVA 2ABKO (Electrica)	120Z0397
HRM047	88–108	250	60	370	RVA 2ABKO (Electrica)	120Z0397
HRM048	161–193	250	60	370	RVA 2ABKO (Electrica)	120Z0397
HRM051-054	161–193	250	70	370	RVA 2ABKO (Electrica)	120Z0397
HRM058T1-060T1	88–108	250	55	440	RVA A4IKL (Electrica)	120Z0398
HRM058U1-060U1, HLM068-081	189–227	330	80	370	RVA 2ABKO (Electrica)	120Z0397
HRP051	161–193	250	70	370	RVA 2ABKO (Electrica)	120Z0397
HLP068-081	189–227	330	80	370	RVA 2ABKO (Electrica)	120Z0397
HRH031	145–175	250	45	370	RVA 2ACKO (Electrica)	120Z0396
HRH032-034	88–108	330	50	370	RVA 2ABKO (Electrica)	120Z0397
HRH036	88–108	330	55	370	RVA 9CKO (Electrica)	120Z0393
HRH038-040	88–108	330	60	370	RVA 2ABKO (Electrica)	120Z0397
HRH041-051	161–193	250	70	370	RVA 2ABKO (Electrica)	120Z0397
HRH054-056, HLH068, HLJ072-083	189–227	330	80	370	RVA 2ABKO (Electrica)	120Z0397

Spare Parts and Accessories

Product, Type	Description	Type(s) applied to	Danfoss Code No.	
Thermostatic Expansion Valves, Types TUA/TUAE/T2/TE2	Bulb strap	all	068U3507	
	Metal Gasket (24 pcs)	TUA/TUAE	068U0015	
	Filter for orifices 0–4 (clear, 24 pcs)	TUA/TUAE	068U1706	
	Filter for orifices 5–9 (blue, 24 pcs)	TUA/TUAE	068U0016	
Thermostatic Expansion Valves, Type TR6	Bulb strap	all	068U3507	
	Fitting 3/8 in. ODM × Chatleff		119F3965	
	Fitting 3/8 in. ODM × Aeroquip		119F3966	
Thermostatic Expansion Valves, Type TGE	Bulb strap	all	067N0557	
Pressure Controls, Types KPU/MP	Capillary tube; 39 in. with 1/4 in. flare coupling nuts on each end	KPU and MP with 1/4 in. M flare	060-017166	
	Permanent magnet coil for servicing and testing	all	018F0091	
	Service kit; o-ring, (4) screws, armature assembly, rubber gasket	EVR 2, 3	032F0181	
	Service kit; diaphragm, o-ring for armature tube, (4) screws T20, (4) screws T15, armature assembly, rubber gasket, o-ring for steel cover, square cover, square gasket for steel cover, support ring	EVR 6	032F8166	
	Service kit; diaphragm assembly, o-ring, (4) screws, armature assembly, rubber gasket	EVR 10	032F0185	
	Service kit; diaphragm assembly, o-ring, (4) screws, armature assembly, rubber gasket, flange gasket	EVR 15, 18	032F0187	
	Service kit; diaphragm assembly, o-ring, (4) screws, armature assembly, compression spring, rubber gasket	EVR 20, 22	032F0189	
	Solenoid Valves, Type EVR	Manual spindle	EVR 20, 22	032F0193
		Piston service kit; (2) o-ring, spring, piston assembly, plastic block, rubber gasket, piston ring	EVR 25	032F3236
		Pilot service kit; armature tube assembly, armature, (2) Al. gaskets, orifice, o-ring	EVR 25	042H0161
		Seal kit; (2) Al. gaskets, (3) o-rings, (2) rubber gaskets	EVR 25	032F3235
		Piston service kit; (5) o-rings, Al. gasket, piston assembly, plastic block, gasket, piston ring, spring	EVR 32	042H0172
		Pilot service kit; (2) Al. gaskets, o-ring, orifice, armature tube assembly, armature	EVR 32	042H0165
		Seal kit; (4) o-rings, (2) Al. gaskets, gasket	EVR 32	042H0160
		Piston seal kit; (5) o-rings, Al. gasket, piston assembly, plastic block, gasket, piston ring, spring	EVR 40	042H0173
	Pressure Controlled Water Valves, Types WVFX	Seal kit; (5) o-rings, (2) Al. gaskets, gasket	EVR 40	042H0160
Rebuild kit; valve disc, (2) o-rings, (8) screws, (2) diaphragms, grease and key		WVFX 10,15	003N4006	
Rebuild kit; valve disc, (2) o-rings, (8) screws, (2) diaphragms, grease and key		WVFX 20	003N4007	
Rebuild kit; valve disc, (2) o-rings, (8) screws, (2) diaphragms, grease and key		WVFX 25	003N4008	
Capillary tube; 39 in. with 1/4 in. flare coupling nuts on each end		WVFX with 1/4 in. M flare	060-017166	
Pressure Regulators, Types KVP/KVR/KVL/KVC/CPCE	Bracket	all	003N0388	
	Schrader valve	all KVP, KVR	034L0006	
Ball Valves, Type GBC	Ball valve service kit	GBC 6, 10, 12, 16, 18, 22	009G7012	
	Ball valve service kit	GBC 28, 35	009G7014	
	Ball valve service kit	GBC 42, 54, 67	009G7016	
	Ball valve replacement cap	GBC 6, 10, 12, 16, 18, 22	009G7210	
	Ball valve replacement cap	GBC 28, 35	009G7211	
	Ball valve replacement cap	GBC 42, 54, 67	009G7212	
Condensing Units, Optyma™	Compressors, fan motors, fan blades, relays, capacitors	various	various—contact Danfoss	
	Enclosure—E1	1/4 to 5/8 hp	119-6040	
	Enclosure—E2	5/8 to 2 hp	119-6041	
	Enclosure—E3	2 1/2 to 3 hp	119-6042	
	Enclosure—E4	4 hp	119-6043	
	Enclosure—E5	5 to 7 hp	119-6044	
Enclosure—E6	9 to 13 1/2 hp	119-6045		

Product, Type	Description	Type(s) applied to	Danfoss Code No.
Reciprocating Compressors, Types MT/MTZ/NTZ	Belt type crankcase heater; 54W, 230V	MT(Z) 018–040, NTZ04–068	7773106
	Belt type crankcase heater; 65W, 110V	MT(Z) 044–081, NTZ096–136	7773109
	Belt type crankcase heater; 65W, 230V		7773107
	Belt type crankcase heater; 65W, 400V		7773117
	Belt type crankcase heater; 65W, 460V		120Z0466
	Belt type crankcase heater; 75W, 110V		7773110
	Belt type crankcase heater; 75W, 230V	MT(Z) 100–160, NTZ215–271	7773108
	Belt type crankcase heater; 75W, 400V		7773118
	Belt type crankcase heater; 75W, 460V		120Z0464
	PTC heater	all	PTC
	Mounting kit—1 and 2 cylinder compressors	MT(Z) 18–81, NTZ048–136	8156001
	Mounting kit—4 cylinder compressors	MT(Z) 100–160, NTZ215–271	8156007
	Mineral oil, 160P; 2 liter can	all MT	7754001
	Mineral oil, 160P; 5 liter can	all MT	7754002
	POE lubricant, 160PZ; 1 liter can	all MTZ	7754019
	Oil sight glass and gasket	all	8156019
	Terminal box; include cover and clamp	MT(Z) 18–44 for 208–230/1/60 18–72 for 200–230/3/60 18–80 for 460/3/60, NTZ048–136 (except 136–1)	8156134
	Terminal box; include cover and clamp	MT(Z) 50–64 for 208–230/1/60 80–160 for 200–230/3/60 100–160 for 460/3/60, NTZ136–1, NTZ215–271	8156135
	Blue spray paint	all	8154001
	Gasket Set; 1 of each size gasket for the MT(Z) line	all—need 2 for: MT(Z)18 for 208–230 and 460 MT(Z)22–28 for 208–230/3 and 460	8156009
	Rotolock Service Valve Set (no gaskets) Suction and Discharge	MT(Z)18 for 208–230 and 460 MT(Z)22–28 for 208–230/3 and 460	7703004
	Rotolock Service Valve Set (no gaskets) Suction and Discharge	MT(Z) 22–40 for 208–230/1 MT(Z) 32–40 for 208–230/3 and 460, NTZ048–068	7703005
	Rotolock Service Valve Set (no gaskets) Suction and Discharge	MT(Z) 44–64 for 208–230/1 MT(Z) 44–72 for 208–230/3 and 460, NTZ096–108	7703006
	Rotolock Service Valve Set (no gaskets) Suction and Discharge	MT(Z) 80–160 for 208–230/3 and 460, NTZ136–271	7703009
	Solder Sleeve P02 (1 ¾ in. rotolock, 1 ½ in. ODF)	Suction: MT(Z) 80–160 for 208–230/3 and 460, NTZ	8153004
	Solder Sleeve P06 (1 in. rotolock, ½ in. ODF)	Suction: MT(Z) 18 for 208–230/1 MT(Z) 18–28 for 208–230/3 and 460 Discharge: MT(Z) 22–40 for 208–230/1 MT(Z) 32–40 for 208–230/3 and 460, NTZ	8153007
	Solder Sleeve P04 (1 ¼ in. rotolock, ¾ in. ODF)	Discharge: MT(Z) 44–64 for 208–230/1 MT(Z) 44–160 for 208–230/3 and 460, NTZ	8153008
	Solder Sleeve P01 (1 in. rotolock, ⅝ in. ODF)	Discharge: MT(Z) 18 for 208–230/1 MT(Z) 18–28 for 208–230/3 and 460, NTZ	8153010
	Solder Sleeve P09 (1 ¼ in. rotolock, ⅝ in. ODF)	Suction: MT(Z) 22–40 for 208–230/1 MT(Z) 32–40 for 208–230/8 and 460, NTZ	8153011

Product, Type	Description	Type(s) applied to	Danfoss Code No.
Reciprocating Compressors, Types MT/MTZ/NTZ	Solder Sleeve P02 (1 3/4 in. rotolock, 7/8 in. ODF)	Suction: MT(Z) 44-64 for 208-230/1 MT(Z) 44-72 for 208-230/3 and 460, NTZ	8153013
	Rotolock Nut, 1 in.	Suction: MT(Z) 18 for 208-230/1 MT(Z) 18-28 for 208-230/3 and 460 Discharge: MT(Z) 18-40 for 208-230/1 MT(Z) 18-40 for 208-230/3 and 460, NTZ	8153122
	Rotolock Nut, 1 1/4 in.	Suction: MT(Z) 22-40 for 208-230/1 MT(Z) 32-40 for 208-230/3 and 460 Discharge: MT(Z) 44-64 for 208-230/1 MT(Z) 44-160 for 208-230/3 and 460, NTZ	8153123
	Rotolock Nut, 1 3/4 in.	Suction: MT(Z) 44-64 for 208-230/1 MT(Z) 44-160 for 208-230/3 and 460, NTZ	8153124
Scroll Compressors, H Series	Wire harness; 5 feet, for 200-230V scroll compressor	models with spade terminals	120Z5056
	Wire harness; 5 feet, for 380-575V scroll compressor	models with spade terminals	120Z5057
	Belt type crankcase heater: 40W, 230V	HRM032-047, HRH031-040	120Z0055
	Belt type crankcase heater: 40W, 400V		120Z0056
	Belt type crankcase heater: 50W, 230V	HRM048-060, HLM068-075, HRM044-056, HLH061-068, HLJ072-075	120Z0057
	Belt type crankcase heater: 50W, 400V		120Z0058
	Belt type crankcase heater: 65W, 230V		120Z0059
	Belt type crankcase heater: 65W, 400V	HLM078-081, HCM094-120, HLJ083, HCJ090-120	120Z0060
	Belt type crankcase heater: 70W, 230V		120Z5040
	Belt type crankcase heater: 70W, 400/440V		120Z5041
	POE lubricant; 1 liter can	HRH, HLH except HLH061	120Z5033
	PVE lubricant, 210HV (FVC68D); 1 liter can	HRH, HLH, HLJ, HCJ	120Z5034
	Mounting kit for 1 compressor, 4 grommets, 4 sleeves, 4 bolts, 4 washers		120Z5005
	Terminal cover, spade terminals (round)	all	120Z5015
Terminal cover, screw terminals (square)		120Z5018	
Scroll Compressors, S Series	Solder sleeve adapter set (1 3/4 in. rotolock, 1 1/8 in. ODF), (1 1/4 in. rotolock, 7/8 in. ODF)	SH090	120Z0125
	Solder sleeve adapter set (1 3/4 in. rotolock, 1 3/8 in. ODF), (1 1/4 in. rotolock, 7/8 in. ODF) *diameter restrictor	SM115, 125, 160, SH105, 120, 140, 161, 184	7765006
	Solder sleeve adapter set (1 3/4 in. rotolock, 1 3/8 in. ODF), (1 1/4 in. rotolock, 7/8 in. ODF)	SM115, 160, SH105, 120, 140, 161, 184	120Z0405
	Solder sleeve adapter set (2 3/4 in. rotolock, 1 1/2 in. ODF), (1 3/4 in. rotolock, 7/8 in. ODF)	SM175, 185, SH240, 380	7765028
	Motor protection module, 24V DC		120Z0141
	Motor protection module, 24V AC	SM115, 125, 160, 185	8169020
	Motor protection module, 230V		8169021
	Motor protection module, 24V DC		120Z0140
	Motor protection module, 24V AC	SH240, 295, 380	8169015
	Motor protection module, 115/230V		8169016
	Belt type crankcase heater; 65W, 460V		120Z0466
	Belt type crankcase heater; 65W, 110V		7773109
	Belt type crankcase heater; 65W, 230V	SM115, 125, 160, SH090, 105, 120, 140, 161, 175, 184	7773107
	Belt type crankcase heater; 65W, 400V		7773117
	Belt type crankcase heater; 65W, 400V		120Z0039
	Belt type crankcase heater; 75W, 110V		7773110
	Belt type crankcase heater, 75W, 230V		7773108
	Belt type crankcase heater, 75W, 400V	SM175, 185, SH240, 295	7773118
	Belt type crankcase heater, 75W, 460V		120Z0464
	Belt type crankcase heater, 130W, 110V		7773121
Belt type crankcase heater, 130W, 230V	SH380	7773122	
Belt type crankcase heater, 130W, 400V		7773123	

Product, Type	Description	Type(s) applied to	Danfoss Code No.
Scroll Compressors, S Series	Service kit for terminal box; includes cover, clamp, terminal block connector	SH090, 105, 120, 140, 161	8156135
	Terminal box, including cover	SM115, 125, 160, 175, 185	8156139
	Terminal box cover	SH140-3, 161-3, 184, 175	120Z0413
	Terminal box, including cover	SH240, 295, 380	120Z0458
	Oil sight glass with gaskets	SM090, 115, 125, 160, 175, 185	8156019
	Mounting kit for 1 compressor: 4 grommets, 4 sleeves, 4 bolts, 4 washers	SM115-185	8156138
	Mounting kit for 1 compressor: 4 grommets, 4 sleeves, 4 bolts, 4 washers	SH090, 105, 120, 140, 161, 175, 184	120Z0066
	Mounting kit for 1 compressor: 4 rigid grommets, 4 sleeves, 4 bolts, 4 washers	SH240, 295, 380	7777045
	Mineral oil, 160P; 2 liter can	all SM	7754001
	Mineral oil, 160P; 5 liter can	all SM	7754002
	Blue spray paint	all	8154001
	Oil equalization adaptor. To connect 7/8 in. tube on 22mm oil sight glass connection; includes (1) 22mm to 7/8 in., (2) gaskets.	all SM, SH	120Z0164
	Oil equalization adaptor. To connect 1/2 in. tube on 22mm oil sight glass connection; includes (1) 22mm to 1/2 in., (2) gaskets.	all SM, SH	120Z0165
	Oil equalization adaptor kit for trio mounting; oil fittings, gasket and adaptors (copper pipes not included)	SM 160, 185	7773112

REFRIGERATION & AIR CONDITIONING

Automatic Controls | Condensing Units | Compressors

80 years

The industry's widest
expertise at your
disposal. We've been
looking ahead since
1933.



Danfoss can accept no responsibility for possible errors in catalogs, brochures, and other printed material. Danfoss reserves the right to alter its products without notice. This also applies to products already on order provided that such alterations can be made without subsequent changes being necessary in specifications already agreed. All trademarks in this material are property of the respective companies. Danfoss and the Danfoss logotype are trademarks of Danfoss A/S. All rights reserved.